

Operating instructions

Precision balances

KERN PBS/PBJ

Version 1.4
03/2013
GB



- D** Weitere Sprachversionen finden Sie online unter **www.kern-sohn.com/manuals**
- CZ** Další jazykové verze najdete na webu pod adresou **www.kern-sohn.com/manuals**
- DK** Yderligere sprogversioner finder de online på **www.kern-sohn.com/manuals**
- E** Más versiones de idiomas se encuentran online bajo **www.kern-sohn.com/manuals**
- EST** Rohkem keeli internetis aadressil **www.kern-sohn.com/manuals**
- F** Vous trouverez d'autres versions de langue online sous **www.kern-sohn.com/manuals**
- GB** Further language versions you will find online under **www.kern-sohn.com/manuals**
- H** A használati utasítás egyéb nyelveken a **www.kern-sohn.com/manuals** címről tölthető le
- I** Trovate altre versioni di lingue online in **www.kern-sohn.com/manuals**
- N** Ytterligere språkversjoner finner du online under **www.kern-sohn.com/manuals**
- NL** Bijkomende taalversies vindt u online op **www.kern-sohn.com/manuals**
- P** Encontram-se online mais versões de línguas em **www.kern-sohn.com/manuals**
- PL** Inne wersje językowe znajdują Państwo na stronie **www.kern-sohn.com/manuals**
- RUS** Другие языковые версии Вы найдете по адресу в Интернете **www.kern-sohn.com/manuals**
- S** Ytterligere språkversioner finns online under **www.kern-sohn.com/manuals**
- SF** Muita kieliversioita löydät osoitteesta **www.kern-sohn.com/manuals**
- SLO** Ostale jezikovne različice boste našli online na **www.kern-sohn.com/manuals**
- TR** Diğer lisan versiyonlarını internetten **www.kern-sohn.com/manuals** adresinden temin edebilirsiniz



KERN PBS/PBJ

Version 1.4 03/2013

Operating instructions Precision balances

Contents

1	Technical data	7
2	Declaration of conformity	11
3	Appliance overview	12
3.1	Keyboard overview	13
3.1.1	Numeric entry	14
3.1.2	Setting the decimal point when entering numerical values	15
3.2	Overview of display	16
4	Basic Information (General)	17
4.1	Proper use	17
4.2	Improper Use	17
4.3	Warranty	17
4.4	Monitoring of Test Resources	18
5	Basic Safety Precautions	18
5.1	Pay attention to the instructions in the Operation Manual	18
5.2	Personnel training	18
6	Transport and storage	18
6.1	Testing upon acceptance	18
6.2	Packaging	18
7	Unpacking, Setup and Commissioning	19
7.1	Installation Site, Location of Use	19
7.2	Unpacking / Scope of delivery	19
7.3	Placing	21
7.4	Mains connection	25
7.5	Switch power supply on	25
7.6	Connection of peripheral devices	26
7.7	Initial Commissioning	26

8	Adjustment.....	27
8.1	Manual adjustment by CAL button	27
8.1.1	Adjustment with internal weight (only models PBJ)	27
8.1.2	Adjustment with external weight (factory setting models PBS).....	29
8.2	Adjustment test.....	31
8.2.1	Adjustment test with external weight.....	32
8.2.2	Adjustment test with internal weight.....	34
8.3	Automatic adjustment by PSC (Perfect Self Calibration), only models PBJ ..	35
8.4	Automatic adjustment by Clock-CAL (model PB only).....	36
8.5	ISO/GLP log.....	38
8.5.1	Setting of adjustment protocol and scale identification number.....	38
9	Verification.....	40
10	Basic Operation	41
10.1	Switch on off balance	41
10.1	Zeroing	41
10.2	Simple weighing	42
10.3	Taring.....	43
10.4	Underfloor weighing.....	44
11	The menu.....	45
11.1	Navigation in the menu	45
11.2	Useful functions.....	48
11.2.1	Recall of last menu	48
11.2.2	Resetting the menu	48
11.3	Menu Lock.....	49
12	Set the installed clock	50
12.1	Date.....	50
12.2	Time	51
12.3	Setting the display for the standby mode.....	52
13	Functions for adaptation to ambient conditions.....	53
13.1	Stability and reaction (average value).....	53
13.1.1	Automatic mode.....	53
13.1.2	Filling mode	53
13.1.3	Standard mode	53
13.1.4	Antivibration mode.....	53
13.1.5	Antiwind mode	53
13.2	Stability Detection Band.....	54
13.3	Tracking.....	54
14	Capacity display.....	54

15	Switch-over weighing unit	55
15.1	Percentage conversion.....	56
16	Application Functions	57
16.1	Parts counting.....	57
16.2	Control weighing and target weighing.....	58
16.2.1	Control weighing (comparator) display type 1	58
16.2.2	Control weighing (comparator) – display type 2	58
16.2.3	Target weighing mode	59
16.3	Density determination	60
16.3.1	Specific measurement of solid weight	60
16.3.2	Table of temperatures and densities	61
16.3.3	Specific measurement of liquid weight	62
16.4	Extreme value recording	62
16.5	Auto Print function	63
16.6	Automatic zero setting	64
16.7	Zero range	64
16.8	Taring /printing at stability (models PBJ)	64
16.9	Formulation mode.....	65
16.10	Automatic saving and zeroing	66
16.11	Animal weighing	67
17	Data output.....	68
17.1	Personal Computer - RS-232C	68
17.1.1	Connecting the Cable	68
17.2	Data Formats.....	69
1.	For measuring values:.....	69
2.	For „oL“ or „-oL“	69
17.3	Using codes of commands	70
17.4	User Settings.....	75
17.4.1	Overview.....	75
17.4.2	Handshaking.....	75
17.4.3	Format	76
17.4.4	Speed of communication	76
17.4.5	Parity / Bit length.....	76
17.4.6	Stop Bits	76
17.4.7	Limiter.....	76
18	Service, maintenance, disposal.....	77
18.1	Clean.....	77
18.2	Service, maintenance	77
18.3	Disposal.....	77
19	Instant help.....	78

1 Technical data

KERN	PBJ 420-3M	PBJ 620-3M	PBJ 1020-3
Readability (d)	0.001 g	0.001 g	0.001 g
Weighing range (max)	420 g	620 g	1020 g
Minimum load (Min)	0.02 g	0.1 g	-
Verification value (e)	0.01 g	0.01 g	-
Verification class	II	I	-
Reproducibility	0.001 g	0.001 g	0.001 g
Linearity	± 0.002 g	± 0.002 g	± 0.003 g
Stabilization time	2.5 sec.	2.5 sec.	2.5 sec.
Warm-up time	4 h	4 h	8 h
Adjustment weight	internal		
Weighing units (calibrated appliances)	g, kg, pcs, %		
Smallest part weight for piece counting	1 mg		
Reference quantities at piece counting	5, 10, 20, 50 100, 200		
Weighing plate, stainless steel	108 x 105 mm		
Dimensions caisse (l x L x h) [mm]	209 x 322 x 78		
Dimensions wind screen [mm]	interior 180 x 193 x 87		
	exterior 202 x 228 x 103		
Net weight (kg)	3.7 kg		
Permitted environmental condition	+10° C to +30° C		
Humidity of air	max. 80 % relative (not condensing)		
Interface	RS-232		
Underfloor weighing device	Hooks		
AC adapter (Primary)	AC 100 -240 V, 400 mA 50/60Hz		
Rated electric power supply	12 V, 1 A		
Pollution Degree	2		
Overvoltage Category	Category II		
Altitude	Up to 2000 m		
Installation Site	device may only be used indoors		

KERN	PBJ 4200-2M	PBJ 6200-2M	PBJ 8200-1M
Readability (d)	0.01 g	0.01 g	0.1 g
Weighing range (max)	4.2 kg	6.2 kg	8.2 kg
Minimum load (Min)	0.5 g	1 g	5 g
Verification value (e)	0.1 g	0.1 g	1 g
Verification class	II	I	II
Reproducibility	0.01 g	0.01 g	0.08 g
Linearity	± 0.02 g	± 0.02 g	± 0.1 g
Warm-up time	4 h	4 h	2 h
Stabilization time	2.5 sec.	2.5 sec.	1.2 sec.
Adjustment weight	internal		
Weighing units (calibrated appliances)	g, kg, pcs, %		
Smallest part weight for piece counting	10 mg	100 mg	
Reference quantities at piece counting	5, 10, 20, 50 100, 200		
Weighing plate, stainless steel	170 x 180 mm		
Dimensions caisse (l x L x h) [mm]	209 x 322 x 78		
Net weight (kg)	4.8 kg		
Permitted environmental condition	+10° C to +30° C		
Humidity of air	max. 80 % relative (not condensing)		
Interface	RS-232		
Underfloor weighing device	Hooks		
AC adapter (Primary)	AC 100 -240 V, 400 mA 50/60Hz		
Rated electric power supply	ÖÖÁ2 V, 1 A		
Pollution Degree	2		
Overvoltage Category	Category II		
Altitude	Up to 2000 m		
Installation Site	device may only be used indoors		

KERN	PBS 420-3M	PBS 620-3M	PBS 1020-3
Readability (d)	0.001 g	0.001 g	0.001 g
Weighing range (max)	420 g	620 g	1020 g
Minimum load (Min)	0.02 g	0.1 g	-
Verification value (e)	0.01 g	0.01 g	-
Verification class	II	I	-
Reproducibility	0.001 g	0.001 g	0.001 g
Linearity	± 0.002 g	± 0.002 g	± 0.003 g
Stabilization time	2.5 sec.	2.5 sec.	2.5 sec.
Warm-up time	4 h	4 h	8 h
Recommended adjustment weight, not added (class)	400 g (E2)	600 g (E2)	1000 g (E2)
Possible Adjustment Points	100 – 420 g	100 – 620 g	100 – 1020 g
Weighing units (calibrated appliances)	g, kg, pcs, %		
Smallest part weight for piece counting	0.001g		
Reference quantities at piece counting	5, 10, 20, 50 100, 200		
Weighing plate, stainless steel	108 x 105 mm		
Dimensions caisse (l x L x h) [mm]	209 x 322 x 78		
Dimensions wind screen [mm]	interior 180 x 193 x 87		
	exterior 202 x 228 x 103		
Net weight (kg)	3 kg		
Permitted environmental condition	+5° C to +40° C		
Humidity of air	max. 80 % relative (not condensing)		
Interface	RS-232		
Underfloor weighing device	Hooks		
AC adapter (Primary)	AC 100 -240 V, 400 mA 50/60Hz		
Rated electric power supply	DC 12 V, 1 A		
Pollution Degree	2		
Overvoltage Category	Category II		
Altitude	Up to 2000 m		
Installation Site	device may only be used indoors		

KERN	PBS 4200-2M	PBS 6200-2M	PBS 8200-1M
Readability (d)	0.01 g	0.01 g	0.1 g
Weighing range (max)	4.2 kg	6.2 kg	8.2 kg
Minimum load (Min)	0.5 g	1 g	5 g
Verification value (e)	0.1 g	0.1 g	1 g
Verification class	II	I	II
Reproducibility	0.01 g	0.01 g	0.1 g
Linearity	± 0.02 g	± 0.02 g	± 0.2 mg
Warm-up time	4 h	4 h	2 h
Stabilization time	2.5 sec.	2.5 sec.	1.2 sec.
Recommended adjustment weight, not added (class)	4 kg (E2)	5 kg (E2)	7 kg (E2)
Possible Adjustment Points	1000 – 4200 g	1000 – 6200 g	1000 – 8200 g
Weighing units (calibrated appliances)	g, kg, pcs, %		
Smallest part weight for piece counting	10 mg		100 mg
Reference quantities at piece counting	5, 10, 20, 50 100, 200		
Weighing plate, stainless steel	170 x 180		
Dimensions caisse (l x L x h) [mm]	209 x 322 x 78		
Net weight (kg)	3 kg		
Permitted environmental condition	+5° C to +40° C		
Humidity of air	max. 80 % relative (not condensing)		
Interface	RS-232		
Underfloor weighing device	Hooks		
AC adapter (Primary)	AC 100 -240 V, 400 mA 50/60Hz		
Rated electric power supply	DC 12 V, 1 A		
Pollution Degree	2		
Overvoltage Category	Category II		
Altitude	Up to 2000 m		
Installation Site	device may only be used indoors		

2 Declaration of conformity



KERN & Sohn GmbH

D-72322 Balingen-Frommern

Postfach 4052

E-Mail: info@kern-sohn.de

Tel: 0049-[0]7433- 9933-0

Fax: 0049-[0]7433-9933-149

Internet: www.kern-sohn.de

Declaration of conformity

EG-Konformitätserklärung
EC- Déclaration de conformité
EC-Dichiarazione di conformità
EC- Declaração de conformidade
EC-Deklaracja zgodności

EC-Declaration of -Conformity
EC-Declaración de Conformidad
EC-Conformiteitverklaring
EC- Prohlášení o shode
EC-Заявление о соответствии

D	Konformitäts- erklärung	Wir erklären hiermit, dass das Produkt, auf das sich diese Erklärung bezieht, mit den nachstehenden Normen übereinstimmt.
GB	Declaration of conformity	We hereby declare that the product to which this declaration refers conforms with the following standards.
CZ	Prohlášení o shode	Tímto prohlašujeme, že výrobek, kterého se toto prohlášení týká, je v souladu s níže uvedenými normami.
E	Declaración de conformidad	Manifetamos en la presente que el producto al que se refiere esta declaración está de acuerdo con las normas siguientes
F	Déclaration de conformité	Nous déclarons avec cela responsabilité que le produit, auquel se rapporte la présente déclaration, est conforme aux normes citées ci-après.
I	Dichiarazione di conformità	Dichiariamo con ciò che il prodotto al quale la presente dichiarazione si riferisce è conforme alle norme di seguito citate.
NL	Conformiteit- verklaring	Wij verklaren hiermede dat het product, waarop deze verklaring betrekking heeft, met de hierna vermelde normen overeenstemt.
P	Declaração de conformidade	Declaramos por meio da presente que o produto no qual se refere esta declaração, corresponde às normas seguintes.
PL	Deklaracja zgodności	Niniejszym oświadczamy, że produkt, którego niniejsze oświadczenie dotyczy, jest zgodny z poniższymi normami.
RUS	Заявление о соответствии	Мы заявляем, что продукт, к которому относится данная декларация, соответствует перечисленным ниже нормам.

Electronic Balance: KERN PBJ / PBS

2004/108/EC	EN 61326-1:2006
2006/95/EC	EN 61010-1: 2010

Datum 27.03.2013
Date

Ort der Ausstellung 72336 Balingen
Place of issue

Signatur
Signature

Albert Sauter
 KERN & Sohn GmbH
Geschäftsführer
Managing director

KERN & Sohn GmbH, Ziegelei 1, D-72336 Balingen, Tel. +49-[0]7433/9933-0
 Fax +49-[0]7433/9933-149, E-Mail: info@kern-sohn.com, Internet: www.kern-sohn.com

3 Appliance overview

Models with readability $d = 0.001$ g:



Models with readability $d \geq 0.01$ g:



1. Windshield
2. Weighing pan
3. Display
4. Keyboard
5. Levelling screw

3.1 Keyboard overview

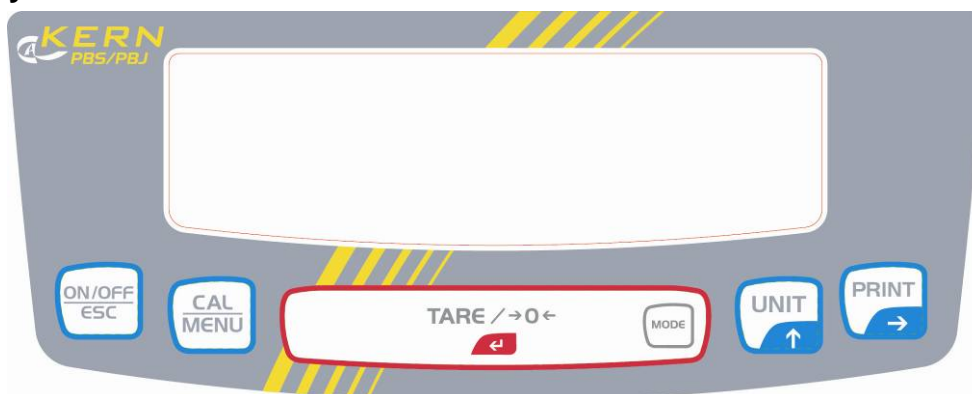





In weighing mode:

Button	Description	Pressed once and released	Keep pressed for about 3 seconds
	[ON/OFF]	Switches between the operation and standby modes.	Exit menu / Return to weighing mode
	[CAL]	Invokes adjustment or menu selection. (*1)	To display the menu element recently set.
	[TARE]	Taring / Setting to zero	No operation
	[UNIT]	Switch over weighing unit (*3)	No operation
	[PRINT]	Issue of weighing value to external appliances (printer, PC)	Issue of date and time to external appliances.





*1 This key is used to set a value when percent (%), number of pieces (PCS), specific weight of solids (▼d) or specific weight of liquid (d) is displayed.

*3 Units different than „g” must be first set in the balance, before they can be used for measurements. Only gram (g), percent (%) and number of pieces (PCS) are factory set.

In menu:

Button	Description	Pressed once and released	Keep pressed for about 3 seconds
	[ON/OFF]	To return to a submenu or weighing mode.	Return to weighing mode
	[CAL]	Moves to the next menu item.	To display the menu element recently set.
	[TARE]	To select or set the menu element recently displayed.	No operation
	[UNIT]	Entering numeric values: Increases the numeric value of flashing digit by 1.	No operation
	[PRINT]	Entering numeric values: To go to the next position.	No operation

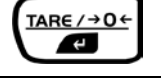
3.1.1 Numeric entry



Button	Description	Function
	Navigation button ↑	Increase flashing digit
	Navigation button →	Digit selection to the right
	Navigation button ←	Confirm entry
	ESC	Cancel input

i

- With numerical input the indicator [#] appears.
- „SET“ indicates that the value has been saved successfully.
- „ERR“ means that the value could not be saved successfully; back to menu by  and repeat enter.

3.1.2 Setting the decimal point when entering numerical values

Entering a decimal point is necessary only for determining the specific gravity or if a multiplier shall be defined for the user-defined unit.

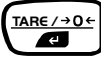
- Repeat actuating the  button until the last digit flashes. Actuate the  button again in order to call up the decimal point setting mode. The reversed triangle symbol ▼ or the current decimal point flashes.
- Actuate the  button in order to move the decimal point to the required position by one digit each.
- Actuate the  button to define the position of the decimal point. The message „SET“ which appears for a short period of time indicates that setting has been completed.

3.2 Overview of display

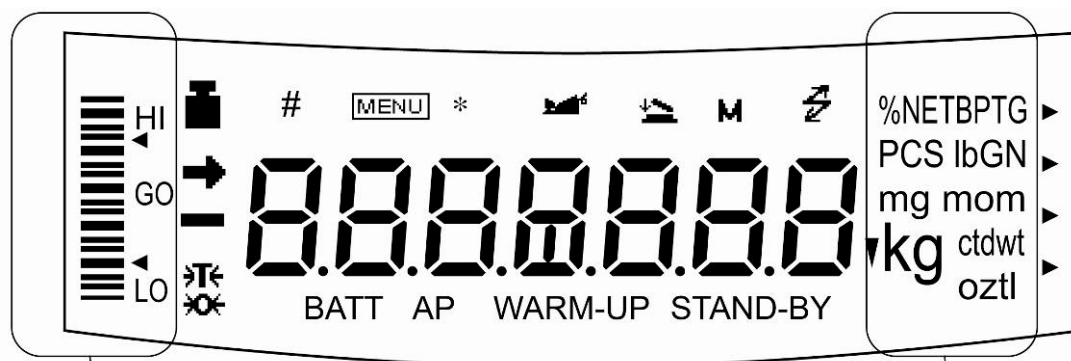

Capacity display

Display of units

Display	Designation	Description
→	Stability display	Indicates that the weighed value is stable. (*1) It marks the currently selected element during menu element selection.
⚖	Tare symbol	Informs about setting an initial tare value.
⚖	Weight symbol	It is displayed during adjusting the measuring range. It indicates adjusting settings during menu selection. Flashes prior to start of automatic adjustment. Note: If automatic adjusting of measuring range is not activated, a user must perform it when this symbol flashes. <ul style="list-style-type: none"> • with built-in weight (PBJ models refer to chapter 8.31.1) • with external weight (PBS models refer to chapter 8.1.2).
[]	Brackets	The non-calibrated value is given in brackets in calibrated scales.
#	Number symbol	Indicates numeric value entry.
MENU	Menu symbol	Appears during menu selection. Always shown when the menu is locked.
*	Asterisk	Indicates that the displayed numeric value is not a mass value.
⚡	Communication symbol	Is lit up during communication with external appliances via RS-232C cable. Shown when communication functions are ON.
▼	Inverse triangle symbol	Indicates the setting of specific weight measurement. It is used as an alternative to the decimal point.
→0←	Zero indicator	
🐾	Animal symbol	Shows the setting of animal weighing function.
📄	Automatic storage and zeroing symbol	Shows the setting of automatic saving and zeroing function.
M	Memory Symbol	Balance is in formula mode
AP	Auto Print symbol	Displays set-up of the Auto Print function.
STAND-BY	Standby mark	Appears when the balance power supply is in stand-by mode. It is also displayed when operational function changes into stand-by mode.

*1 Stabilisation symbol
When the stabilisation symbol is illuminated for a long time, the displayed value may oscillate when a weight is slowly changed or stabilisation detection range is set to high value.

4 Basic Information (General)

4.1 Proper use

The balance you purchased is intended to determine the weighing value of material to be weighed. It is intended to be used as a “non-automatic balance”, i.e. the material to be weighed is manually and carefully placed in the centre of the weighing pan.. As soon as a stable weighing value is reached the weighing value can be read.

4.2 Improper Use

Do not use balance for dynamic add-on weighing procedures, if small amounts of goods to be weighed are removed or added. The “stability compensation“ installed in the balance may result in displaying an incorrect measuring value! (Example: Slowly draining fluids from a container on the balance.)

Do not leave permanent load on the weighing pan. This may damage the measuring system.

Impacts and overloading exceeding the stated maximum load (max) of the balance, minus a possibly existing tare load, must be strictly avoided. Balance may be damaged by this.

Never operate balance in explosive environment. The serial version is not explosion protected.

The structure of the balance may not be modified. This may lead to incorrect weighing results, safety-related faults and destruction of the balance.

The balance may only be used according to the described conditions. Other areas of use must be released by KERN in writing.

4.3 Warranty

Warranty claims shall be voided in case

- Our conditions in the operation manual are ignored
- The appliance is used outside the described uses
- The appliance is modified or opened
- Mechanical damage or damage by media, liquids, natural wear and tear
- The appliance is improperly set up or incorrectly electrically connected
- The measuring system is overloaded

4.4 Monitoring of Test Resources

In the framework of quality assurance the measuring-related properties of the balance and, if applicable, the testing weight, must be checked regularly. The responsible user must define a suitable interval as well as type and scope of this test. Information is available on KERN's home page (www.kern-sohn.com) with regard to the monitoring of balance test substances and the test weights required for this. In KERN's accredited DKD calibration laboratory test weights and balances may be calibrated (return to the national standard) fast and at moderate cost.

5 Basic Safety Precautions

5.1 Pay attention to the instructions in the Operation Manual

Carefully read this operation manual before setup and commissioning, even if you are already familiar with KERN balances.

5.2 Personnel training

The appliance may only be operated and maintained by trained personnel.

6 Transport and storage

6.1 Testing upon acceptance

When receiving the appliance, please check packaging immediately, and the appliance itself when unpacking for possible visible damage.

6.2 Packaging



- ⇒ Keep all parts of the original packaging for a possibly required return.
- ⇒ Only use original packaging for returning.
- ⇒ Prior to dispatch disconnect all cables and remove loose/mobile parts.
- ⇒ Reattach possibly supplied transport securing devices.
- ⇒ Secure all parts such as the glass wind screen, the weighing platform, power unit etc. against shifting and damage.

7 Unpacking, Setup and Commissioning

7.1 Installation Site, Location of Use

The balances are designed in a way that reliable weighing results are achieved in common conditions of use.

You will work accurately and fast, if you select the right location for your balance.

Therefore, observe the following for the installation site:

- Operate the device only indoors.
- Place the balance on a firm, level surface;
- Avoid **extreme heat as well as temperature fluctuation** caused by installing next to a radiator or in the direct sunlight;
- Protect the balance against direct draughts due to open windows and doors;
- Avoid jarring during weighing;
- Protect the balance against high humidity, vapours and dust;
- Do not expose the device to extreme dampness for longer periods of time. Non-permitted condensation (condensation of air humidity on the appliance) may occur if a cold appliance is taken to a considerably warmer environment. In this case, acclimatize the disconnected appliance for ca. 2 hours at room temperature.
- Avoid static charge of goods to be weighed or weighing container.

If electro-magnetic fields or static charge occur, or if the power supply is unstable major deviations on the display (incorrect weighing results) are possible. In that case, the location must be changed.

7.2 Unpacking / Scope of delivery

Remove device and accessories carefully from packaging, remove packaging material and place device at the planned work place. Verify that there has been no damage and that all packing items are present.

Scope of delivery / serial accessories:

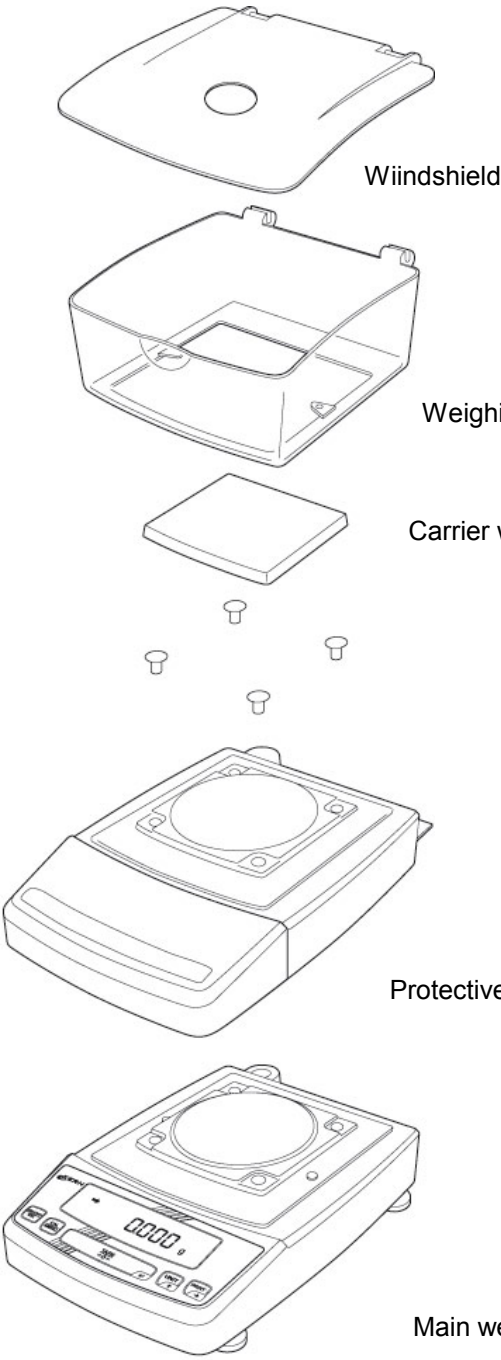
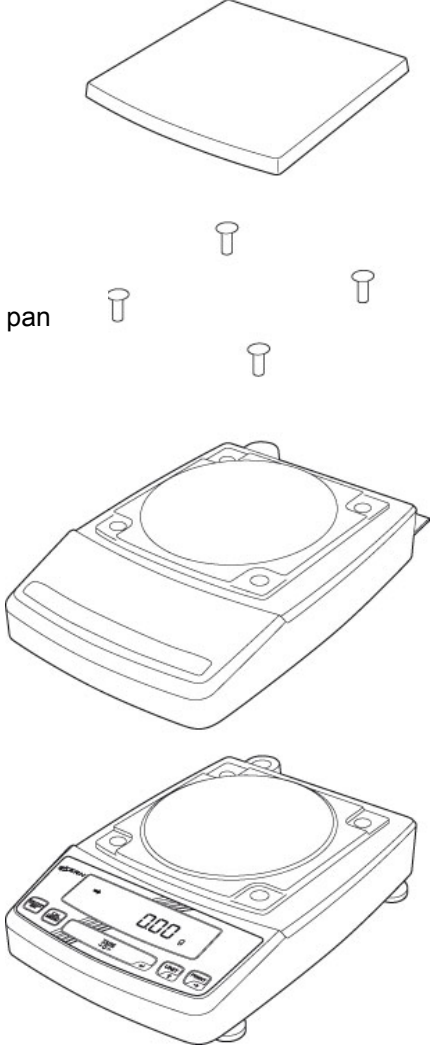
Models with readability $d = 0.001 \text{ g}$:	Models with readability $d \geq 0.01 \text{ g}$:
 <p>Windshield</p> <p>Weighing pan</p> <p>Carrier weighing pan</p> <p>Protective cover</p> <p>Main weighing unit</p> <p>2 screws</p> <p>2 Fixiing screws Protection hood</p>	
<ul style="list-style-type: none"> • Mains adapter • Operating instructions • Menu overview 	

7.3 Placing

⇒ Remove transport guard (models PBJ)

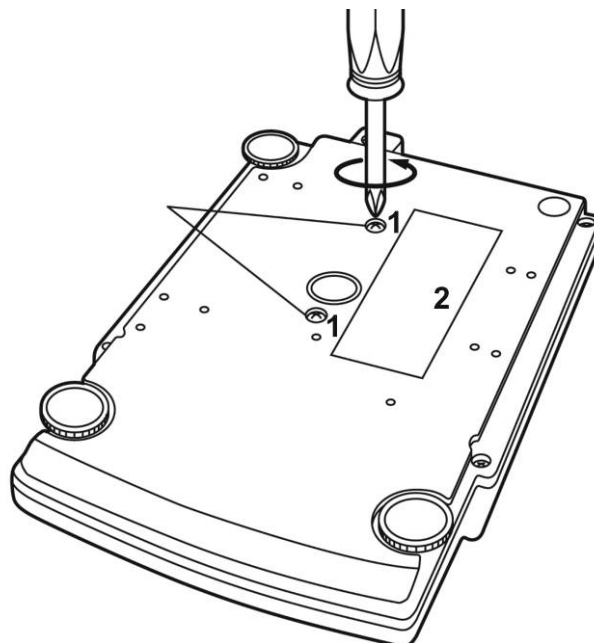

To loosen the transport guard, turn both transport screws [1] anti-clockwise until they are locked (refer to sign [2]).

For transport, turn both transport screws clockwise until they are locked.

⇒ **Mount safety hood**

Remove protective foil from adhesive strips and mount the safety hood so that it does not contact the weighing plate.

⇒ **Levelling**

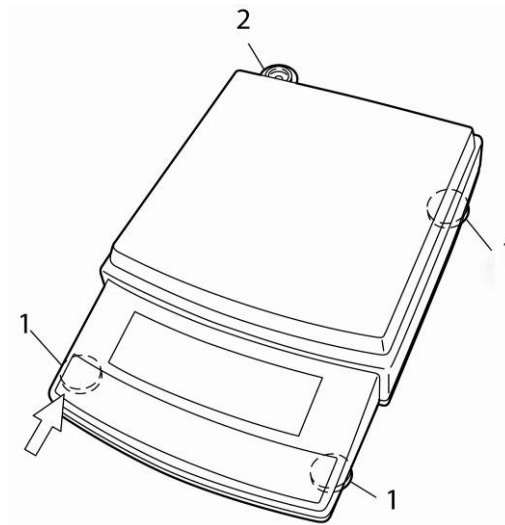

⇒ Turn in all three foot screws [1] as far as they go.

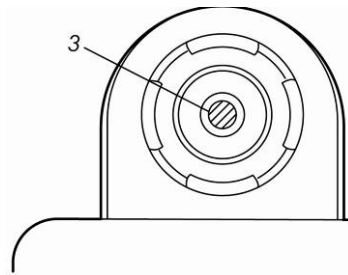

- ⇒ Slightly press down the left front side of the scale and turn out the two front foot screws until the air bubble [3] in the spirit level [2] is within the prescribed circle.
- ⇒ While continuing to exert a slight pressure to the front side of the scale, turn out the rear foot screw until the scale stands in stable position.
- ⇒ Check levelling regularly.

⇒ **Installation of weighing plate**

Models with readability $d \geq 0.01$ g:

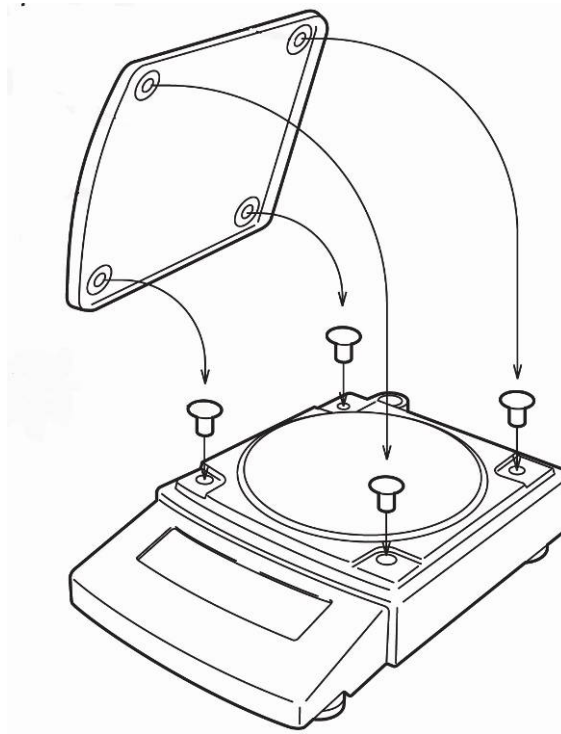

Models with readability = 0.001 g:

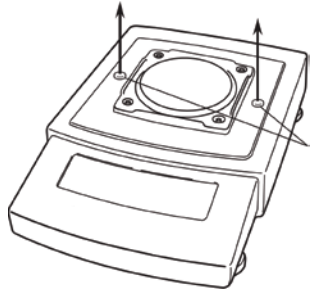

Remove rubber plug as shown in picture.

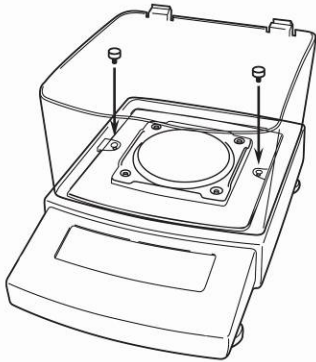

Attach wind guard and fix it by means of screws.

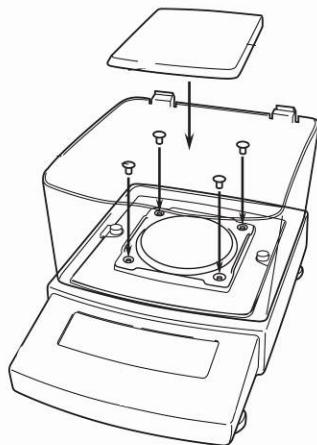

Install weighing pan as per illustration.
Note the correct position.

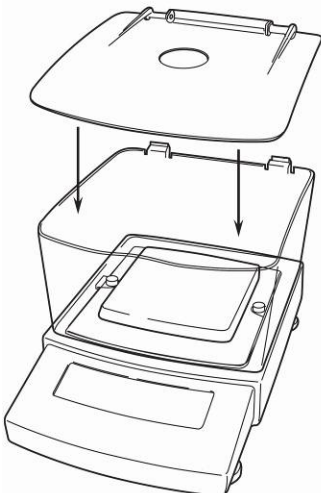

Place the wind guard cover.

7.4 Mains connection

Power is supplied via the external mains adapter. The stated voltage value must be the same as the local voltage.

Only use original KERN mains adapters. Using other makes requires consent by KERN.



Models PBJ:

Prior to mains connection, loosen the transport guard screws at the scale according to the sign in any case, see chapter 7.3

7.5 Switch power supply on

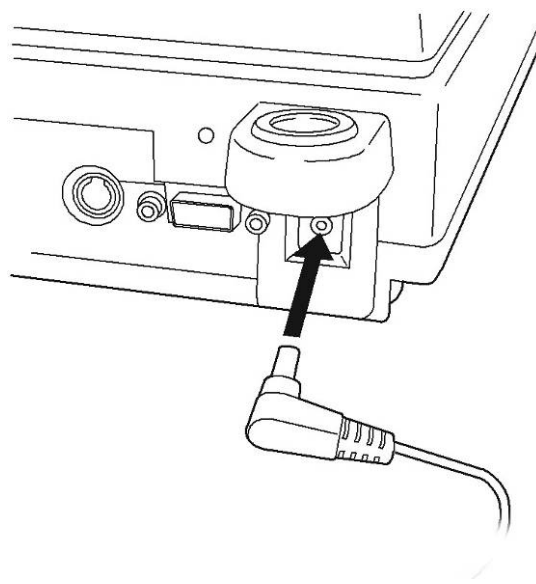

- ⇒ Supply power to balance via mains adapter. The display lights up and the balance carries out a selftest.

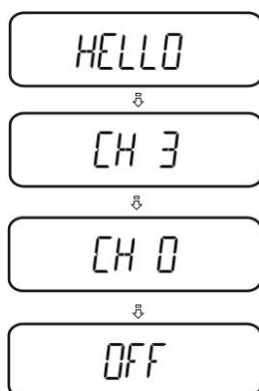

Models PBS

- ⇒ After a successful selftest „OFF“ is displayed.
- ⇒ To switch on press the **ON/OFF** button. The balance will carry out a display test. As soon as the weight display appears, the balance is ready for weighing.

7.6 Connection of peripheral devices

Before connecting or disconnecting of additional devices (printer, PC) to the data interface, always disconnect the balance from the power supply.

With your balance, only use accessories and peripheral devices by KERN, as they are ideally tuned to your balance.

Terminal for external devices:

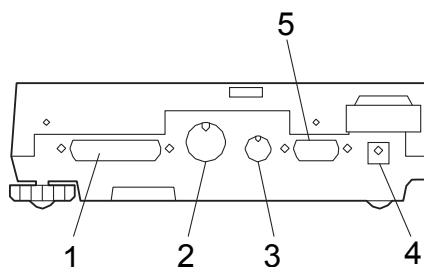

Interfaces at the balance back

- 1 RS-232C interface
- 2 DATA IO interface
- 3 AUX interface
- 4 DC-IN connection
- 5 Keyboard interface

7.7 Initial Commissioning

In order to obtain exact results with the electronic balances, your balance must have reached the operating temperature (see warming up time chap. During this warming up time the balance must be connected to the power supply (mains, accumulator or battery).

The accuracy of the balance depends on the local acceleration of gravity. Strictly observe hints in chapter Adjustment.

8 Adjustment

As the acceleration value due to gravity is not the same at every location on earth, each balance must be coordinated - in compliance with the underlying physical weighing principle - to the existing acceleration due to gravity at its place of location (only if the balance has not already been adjusted to the location in the factory). This adjustment process must be carried out for the first commissioning, after each change of location as well as in case of fluctuating environment temperature. To receive accurate measuring values it is also recommended to adjust the balance periodically in weighing operation.

- i** Observe stable environmental conditions. A warming up time (see chapter 1) is required for stabilization. Ensure that there are no objects on the weighing pan.

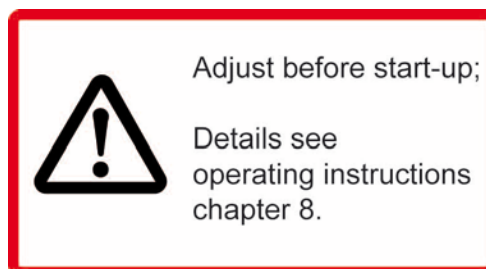

(only models PBJ)

8.1 Manual adjustment by CAL button

The scales have been set by the manufacturer so that adjustment can be started directly from the weighing mode using the **CAL** button.

- Models PBJ: Adjustment with internal weight
- Models PBS: Adjustment by external weight (blocked for calibrated scales)

Other adjustment procedures can be activated in the menu.

8.1.1 Adjustment with internal weight (only models PBJ)

- i** **Condition:** Menu setting „I.CAL“ / Menu element **1**

1. In weighing mode press . I-CAL is displayed.

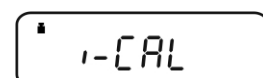
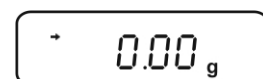



If „I-CAL“ is not displayed, press  to return into weighing mode and activate menu element 1, see menu overview.

2. Press the  button and adjustment will take place automatically.

3. After successful adjustment the balance automatically returns to weighing mode.
 In case of an adjustment error (e.g. objects on the weighing plate) the display will show an error message, repeat adjustment.
 When an optional printer is connected and the GLP function is connected, the adjustment log will be edited, see chap. 8.5

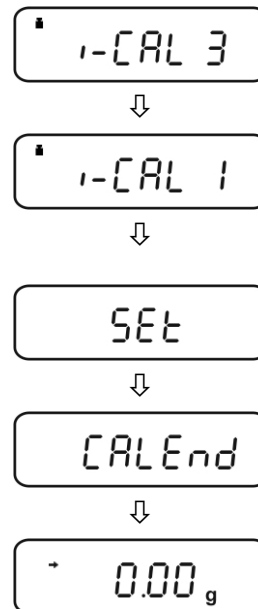

Printout example (KERN YKB-01N):

----- CAL -INTERNAL -----	Adjustment mode
KERN	Company
TYPE PBJ4200-2M	Model
SN WBxxxxxxxx	Serial no.
ID 1234	Balance identification no. (see chap. 8.5.1)
DATE 27-01-2011	
TIME 11.54.53	
REF 4000.00g	Used adjustment weight
BFR 4003.97g	Before adjustment
AFT 4000.00g	After adjustment
-COMPLETE	
-SIGNATURE-	prepared by

8.1.2 Adjustment with external weight (factory setting models PBS)



- **Condition:** menu setting „E-CAL“ / menu element 3. .
- At verified balances, the adjustment is locked by a switch (except accuracy class I). To disable the access lock, destroy the seal and actuate the adjustment switch. Position of the adjustment switch see chap. 9
Attention:
 After destruction of the seal the balance must be re-verified by an authorised agency and a new verification wire/seal mark fitted before it can be reused for applications subject to verification.
- Carry out adjustment as near as possible to the balance's maximum weight (recommended adjustment weight see chap. 1). Weights of different nominal values or tolerance classes may be used for adjustment but are not optimal for technical measuring. The accuracy of the adjustment weight must correspond approximately to or, if possible, be better than, the readability **d** of the balance.
 Information about test weights you will find in the internet under <http://www.kern-sohn.com>

⇒ In weighing mode press . E CAL is displayed.

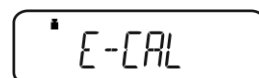
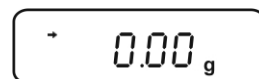

If „E-CAL“ is not displayed, press  to return into weighing mode and activate menu element 3, see menu overview.

⇒ Press,  the weight value of the recommended adjustment weight (see chap. 1) appears flashing.



If the weight value shall be changed, press , the active digit flashes. Carry out the desired setting using navigation buttons (see chapter 3.1.1 „Numeric input“).

⇒ Carefully place adjusting weight in the centre of the weighing plate ,press .



⇒ Wait until the zero display flashes.

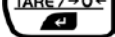

Remove adjustment weight and press . After successful adjustment the balance automatically returns to weighing mode.

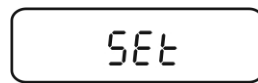

In case of an adjustment error (e.g. objects on the weighing plate) the display will show an error message, repeat adjustment.

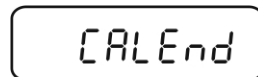

When an optional printer is connected and the GLP function is connected, the adjustment log will be edited, see chap.

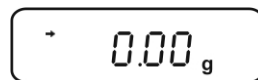



8.5. Printout example (KERN YKB-01N):

----- CAL -EXTERNAL -----	Adjustment mode
KERN	Company
TYPE PBS4200-2M	Model
SN WBxxxxxxxxx	Serial no.
ID 1234	Balance identification no. (see chap. 8.5.1)
DATE 27-01-2011	
TIME 11.54.53	
REF 4000.00g	Used adjustment weight
BFR 3999.97g	Before adjustment
AFT 4000.00g	After adjustment
-COMPLETE	
-SIGNATURE-	prepared by

8.2 Adjustment test

Activate function:

⇒ Press  3 times in weighing mode. Menu group 1 „Adjustment“ is displayed, the indicator  flashes.

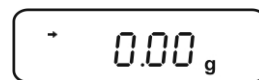

⇒ Acknowledge by , the current setting flashes.

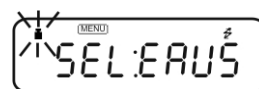

 Adjustment with internal weight „I-CAL“ (only models PBJ, see chap. 8.1.1), Menu element **1**



 Adjustment test with internal weight „I-tESt“ (only models PBJ, see chap. 8.2.2), Menu element **2**

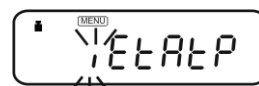

 Adjustment with external weight „E-CAL“ (see chap. 8.1.2), Menu element **3**



 Adjustment test with external weight „E-tESt“ (see chap. 8.2.1), Menu element **4**



⇒ Acknowledge by .

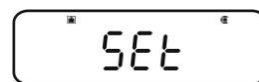

⇒ Press  repeatedly or for 3 s and the scale returns into weighing mode

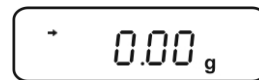

i The saved setting can now be called up directly via .

8.2.1 Adjustment test with external weight



- **Condition:** Menu setting „E-tEst“ / Menu element 4
- At verified balances, the adjustment test is locked by a switch (except accuracy class I). To disable the access lock, destroy the seal and actuate the adjustment switch. Position of the adjustment switch see chap. 9

Attention:

After destruction of the seal the balance must be re-verified by an authorised agency and a new verification wire/seal mark fitted before it can be reused for applications subject to verification.

⇒ In weighing mode press . E-tEst is displayed.

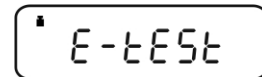
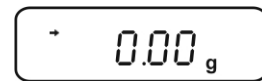

If „E-tEst“ is not displayed, press  to return into weighing mode and activate menu element 4, see menu overview.

⇒ Press , checking is started. The displayed weight value of the recommended adjustment weight (see chapter 1) flashes.



If the weight value shall be changed, press , the active digit flashes. Carry out the desired setting using navigation buttons (see chapter 3.1.1 „Numeric input“).

⇒ Carefully place adjusting weight in the centre of the weighing plate, press .



⇒ Wait until the zero display flashes.

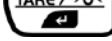

⇒ Remove adjustment weight and press .
Wait for a short period of time, the difference to the previous adjustment is displayed.

d * 0.01 g

Either

press , the d-value is reset to zero.
Adjustment of balance by resetting.

SEt



CALEnd



* 0.00 g

or

⇒ press , the d-value is not reset to zero. No adjustment occurs.

* 0.00 g

8.2.2 Adjustment test with internal weight

i Condition: Menu setting „I-tEst“/ menu element 2

⇒ In weighing mode press . I-tEst is displayed.

→ 0.00 g



■ I-tEst

i If „I-tEst“ is not displayed, press  to return into weighing mode and activate menu element 2, see menu overview.

⇒ Press , checking is automatic.

■ I-tEst 2



■ I-tEst 1



■ d * 0.01 g

Wait for a short period of time, the difference to the previous adjustment is displayed.

⇒ Either

Press , the d-value is reset to zero.
Adjustment of balance by resetting.



CAL End



→ 0.00 g

or



⇒ Press , the d-value is not reset to zero. No adjustment occurs.

→ 0.00 g

8.3 Automatic adjustment by PSC (Perfect Self Calibration), only models PBJ

The PSC function determines the ambient temperature of the scale at any time. If the tolerance groups are exceeded upwards or downwards, this is signalled and the necessary adjustment is carried out fully automatically. This will ensure that the scale is ready at any time.

Activate function:

⇒ Press  3 times in weighing mode. Menu group 1 „Adjustment“ is displayed, the indicator  flashes.

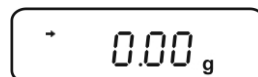

⇒ Acknowledge by , the current setting flashes.

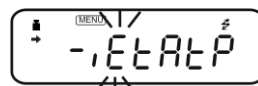
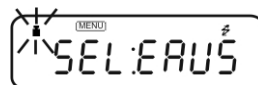

⇒ Press  several times until „A“ flashes.

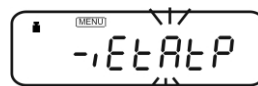

⇒ Acknowledge with .

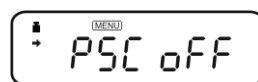

⇒  is used to change-over among the following settings.



„PSC on“ (menu element **5**) = function activated

„PSC off“ (menu element **6**) = function deactivated

The current setting is marked by the stability display (→).

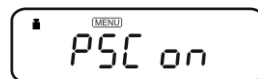

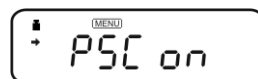
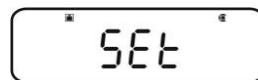

⇒ Acknowledge selection by .

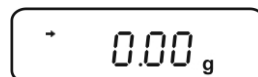

⇒ Press  repeatedly or for 3 s and the scale returns into weighing mode.



i

- The flashing weight symbol  signals that automatic adjustment is imminent.
- In order to avoid that adjustment is started possibly during a series of measurements, actuate  as soon as the weight symbol flashes. This will interrupt automatic adjustment.
- If the PSC function has not been activated, the operator has to adjust by means of an internal adjustment weight (chapter 8.1.1) as soon as the weight symbol  flashes.



8.4 Automatic adjustment by Clock-CAL (model PB only)

With the help of its internal adjusting weight and integrated clock the balance can be set to carry out automatic adjustment at set times (up to three times daily, „ACALt1“, „ACALt2“ und „ACALt3“). Clock-CAL is a very convenient function, when calibration logs are desired to be made for regular calibrations, or when wishing span calibrations during break times to avoid interruption of measurement work.

In order to execute Clock-Cal the following conditions must be met at the defined time. If the conditions are not met within one minute, adjustment is skipped.



- The scale must be in weighing or standby mode.
- The stability display must be indicated.
- The load at the weighing plate must be near zero.
- No other adjustment process must be started.

i

- The weight symbol  blinks for about two minutes as notification of span calibration before it begins.
- In order to avoid that adjustment is started possibly during a series of measurements, actuate  as soon as the weight symbol flashes. This will interrupt automatic adjustment.
- If all three times are set to „00:00“ the function is switched off.

Setting the time for Clock-CAL:

Example „ACALt1“ to 12:00 p.m..

⇒ Press  3 times in weighing mode. Menu group 1 „Adjustment“ is displayed, the indicator  flashes.

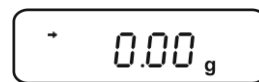

⇒ Acknowledge by , the current setting flashes.

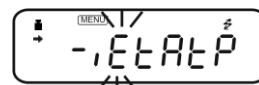
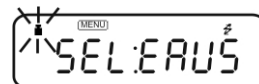

⇒ Press  several times until „t“ flashes.



⇒ Acknowledge by , the first time „tCAL t1“ (menu element 7) is displayed.



⇒ Acknowledge by , the current setting is displayed (the active digit flashes).



⇒ Carry out the desired setting using navigation buttons (see chapter 3.1.1 „Numeric input“).

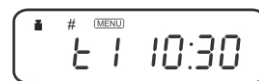

⇒ Acknowledge by .

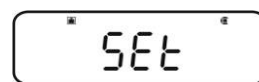

⇒ Call up „tCAL t2“ (menu element 8) or „tCAL t3“ (menu element 9) by  and enter required time as described above.



⇒ Back to weighing mode press  again or for 3 s.

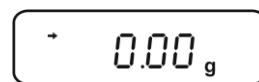

8.5 ISO/GLP log

Quality assurance systems require printouts of weighing results as well as of correct adjustment of the balance stating date and time and balance identification. The easiest way is to have a printer connected.

- i** Make sure that the communication parameter of balance and printer are the same.
Communication parameter, see chap. 17.4

8.5.1 Setting of adjustment protocol and scale identification number

⇒ Actuate  in weighing mode until „S“ flashes.

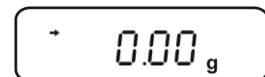

⇒ Acknowledge with .

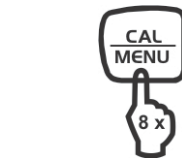

⇒ Press  several times until „t“ flashes.

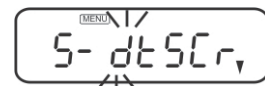

⇒ Acknowledge with .

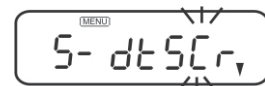

⇒ Press .

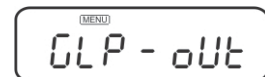

⇒  is used to change-over among the following settings.

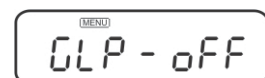
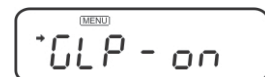



„GLP on“ (menu element 68) = function activated

„GLP off“ (menu element 69) = function deactivated

The current setting is marked by the stability display (→).

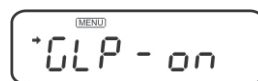
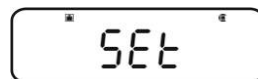
⇒ Acknowledge selection by  .



⇒ Return to menu by  .



⇒ Use  to invoke menu element 70

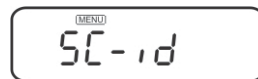

⇒ Acknowledge by , the currently set scale identification number is displayed (the active digit flashes).



⇒ Use the navigation buttons and enter a 4-digit number between „0000“ and „9999“ eingeben (see chapter 3.1.1 „Numerical entry“).



⇒ Acknowledge with  .

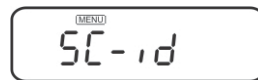
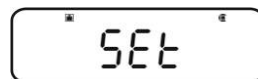

⇒ Back to weighing mode press  again or for 3 s.

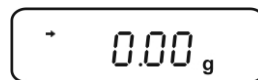

9 Verification

General introduction:

According to EU directive 90/384/EEC or 2009/23EG balances must be officially verified if they are used as follows (legally controlled area):

- For commercial transactions if the price of goods is determined by weighing.
- For the production of medicines in pharmacies as well as for analyses in the medical and pharmaceutical laboratory.
- For official purposes
- For manufacturing final packages

In cases of doubt, please contact your local trade in standard.

Verification notes:

An EU type approval exists for balances described in their technical data as verifiable. If a balance is used where obligation to verify exists as described above, it must be verified and re-verified at regular intervals.

Re-verification of a balance is carried out according to the respective national regulations. The validity for verification of balances in Germany is e.g. 2 years.

The legal regulation of the country where the balance is used must be observed!



Verification of the balance is invalid without the seal.

The seal marks attached on verified balances point out that the balance may only be opened and serviced by trained and authorised specialist staff. If the seal mark is destroyed, verification loses its validity. Please observe all national laws and legal regulations. In Germany a re-verification will be necessary.

Position of seals and adjusting switch

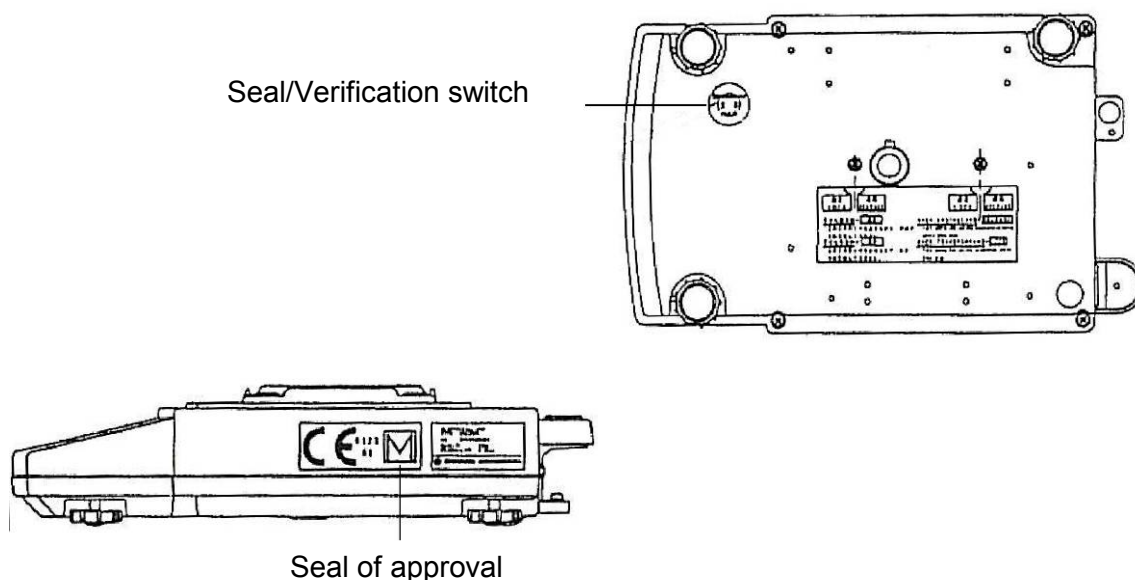

10 Basic Operation

10.1 Switch on off balance

Start-up:

1. After connection to the power supply the balance displays **OFF**. For switching on, press  the scale carries out a segment test and starts automatically in weighing mode.

OFF



* 0.00 g

2. If the scale is in standby mode, press . The scale is ready for service immediately without heating up time.

STAND-BY



* 0.00 g

Switching off:

1. Press ; the balance changes into standby mode, that means that the balance is now in state ready-for-operation..
2. To switch-off the balance completely, separate balance from power supply.

STAND-BY

 If **[WAIT]** or **[SET]** are displayed, do not separate the balance from power supply.

10.1 Zeroing

⇒ Unload the balance

⇒ Press , the zero display appears.

10.2 Simple weighing

i In order to obtain exact weighing results, your balance must have reached the operating temperature (see warming up time chap. 1).

- ⇒ Wait for zero display, reset to zero using .
- ⇒ Place goods to be weighed on balance.
- ⇒ Wait until the stability display appears (→).
- ⇒ Read weighing result.

i Error display during the weighing process

oL	Overload, the capacity of the scale has been exceeded
-oL	Under-load, the load at the scale is too low

When an optional printer is connected, the weighing value can be edited.

Printout examples (KERN YKB-01N):

1. Verified models:



50.5[7] g

Weighing value, the non-calibrated value is given in brackets in calibrated scales.

2. Non-verified models



1999.93 g

Measuring Value

3. Output date/time



08:51 25/02/11

Output date/time



50.5[7] g

Output weight value

10.3 Taring

The dead weight of any weighing container may be tared away by pressing a button, so that the following weighing procedures show the net weight of the goods to be weighed.

- ⇒ Put weighing container on the weighing pan.
- ⇒ Wait until the stability display appears (→), then press . The weight of the container is now internally saved.
- ⇒ Weigh the material.
- ⇒ Wait until the stability display appears (→).
- ⇒ Read net weight.

Note:



- When the balance is unloaded the saved taring value is displayed with negative sign.
- To delete the stored tare value, remove load from weighing plate and press .
- The taring process can be repeated any number of times. The limit is reached when the whole weighing range is exhausted.
- The PRE-TARE function for subtracting a known container weight can be activated in the menu, see chapter / menu element 36

10.4 Underfloor weighing

Objects unsuitable for placing on the weighing scale due to size or shape may be weighed with the help of the flush-mounted platform.

Proceed as follows:

- Switch off the balance.
- Open closing cover at the balance bottom.
- Place weighing balance over an opening.
- Attach load to hook and carry out weighing procedure.



CAUTION

- **Always ensure that all suspended objects are stable enough to hold the desired goods to be weighed safely (danger of breaking).**
- **Never suspend loads that exceed the stated maximum load (max) (danger of breaking)**

Always ensure that there are no persons, animals or objects that might be damaged underneath the load.



NOTICE

After completing the underfloor weighing the opening on the bottom of the balance must always be closed (dust protection).

11 The menu

11.1 Navigation in the menu

The menu consists of 7 groups and 4 levels.

The configuration of the menu shows this structure where access to the required functions is facilitated by the numbering of the relevant menu elements.

For navigation in the menu please use the enclosed menu is displayed.

i For navigation in the menu the  symbol is displayed.

Call function:

- Press  3 times in weighing mode.

The first menu group „Adjustment“ is displayed, the indicator  flashes.

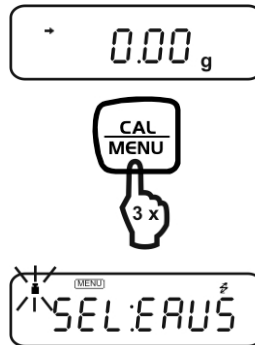

- Select the required menu group by . When pressing , the relevant symbols flashes; refer to the explanation below.



Menu group	Flashing symbol	Description
1		Adjustment
2	Analog display	Capacity display, control and target weighing
3	E	Installation environment and taring
4	A	Application measurements and automatic output
5	U	Conversion of units and specific weight measurement
6	S	Setting of time and generation of an adjustment data set
7		Communication with external devices

Making settings:

As an example, the condition for evaluating the stability of 1 count (menu element 27) to 4 counts (menu element 29) shall be set. Use the number and look for the function in the menu overview and make the following settings at the scale.

⇒ Call up menu group 3, the symbol „E“ flashes.

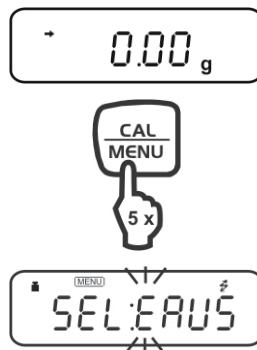

⇒ Press , the next menu level is displayed.

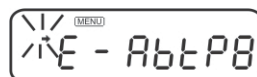

⇒ Press  repeatedly until „b“ flashes.

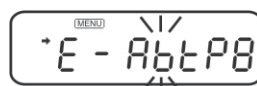

- ⇒ Press , „Eb-1“ (menu element 27) is displayed.
The stability display (→) lights if „Eb-1“ is the current setting.

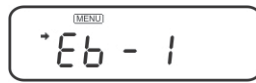

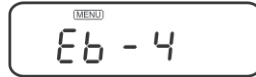

- ⇒ Repeatedly press , until „Eb-4“ (menu element 29) is displayed.



- ⇒ Save by . „SET“ followed by the current setting „Eb-4“ is displayed, characterized by the stability display (→).



Back to menu or onto weighing mode:

- ⇒ Actuate  for a short time, back to menu.
- ⇒ Actuate  for a long time, back to weighing mode.

11.2 Useful functions

11.2.1 Recall of last menu

This function is useful if an application requires frequent changes at a certain menu element.

In weighing mode or when selecting the menu, keep the  button pressed for approx. 3 seconds. Then the menu element is displayed which has been changed or set lastly.

11.2.2 Resetting the menu

This function is used to reset all settings in the menu to default setting. Default settings are marked by “#” in the menu overview.

 Select menu element **72** in the menu overview

⇒ Actuate  in weighing mode until „S“ flashes.

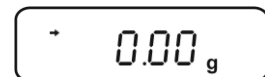

⇒ Acknowledge with .

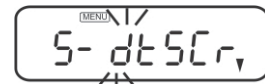

⇒ Press  several times until „r“ flashes.



⇒ Acknowledge with . The query for menu reset „rESEt?“ is displayed

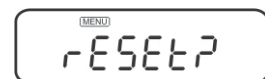

⇒ Press  „rESEt“ indicates that menu reset has been completed.

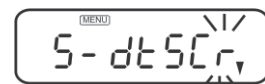
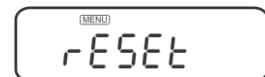

⇒ Back to weighing mode press  repeatedly or for 3 s.

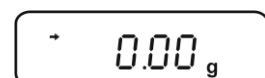

11.3 Menu Lock

Locking the access to the menu:

- ⇒ Connect scale to power supply.
- ⇒ During the off display, keep  pressed until „Locked“ appears.



Menu access is rejected now and the message „Locked“ appears as soon as the operator tries to select a menu.

Canceling the access lock:

- ⇒ Disconnect scale from power supply. Wait for 10 seconds, then re-connect scale.
- ⇒ During the off display, keep  pressed until „release“ appears.



12 Set the installed clock

12.1 Date

 Select menu element 63, see chap. 11.1

⇒ Actuate  in weighing mode until „S“ flashes.

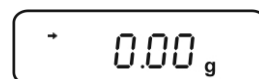

⇒ Acknowledge with .



⇒ Press  several times until „d“ flashes.



⇒ Press .



⇒ Press  again, the current date is displayed.

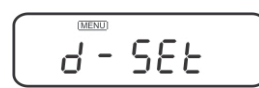

⇒ Change by means of navigation buttons (see chapter 3.1.1 „Numerical entry“).



⇒ Confirm input by .

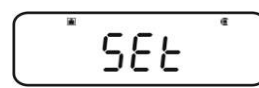

Either





⇒ Return to weighing mode using .

or

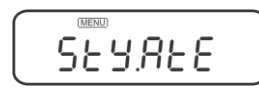
⇒ Press  to go to date format setting



⇒ Press , the current set format is displayed.

⇒  is used to select among the following formats

Y.m.d. Menu element **63a**

d.m.Y. Menu element **63b**

m.d.Y. Menu element **63c**

⇒ Confirm input by .

or

⇒ Back to weighing mode - press  repeatedly or for 3 s.

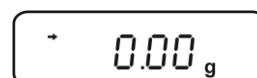

- The installed clock will carry out the corrections automatically for a leap year.
- If the  button is actuated to complete date setting, the seconds are set to zero. If the date is set after the time, the second value is thus not correct. Thus it is important to set the date first and then the time and/or correct the second value by means of the second correction function (\pm), see chapter 12.3.

12.2 Time

 Select menu element **64**, see chap. 11.1

Set time in the same way as the date (see chap. 12.1).

12.3 Setting the display for the standby mode

Define the items which shall be displayed in standby mode.

 Select menu element **65** if the time shall be displayed, see chapter 11.1

 Select menu element **66** if the date shall be displayed, see chapter 11.1

 Select menu element **67** if neither the time nor the date shall be displayed, see chapter 11.1

i

If the time is displayed in standby mode, you have the following functions available

- **Display of seconds**

Using  you can activate display/hiding of seconds.

- **Correction by ± 30 seconds:**

Actuate  while the seconds are displayed. If the value is between 00 - 29 seconds, the seconds are rounded off to zero. If the value is between 30 - 59 seconds, it is round up by one minute and 00 is displayed for seconds.

13 Functions for adaptation to ambient conditions

13.1 Stability and reaction (average value)

Exists the possibility to tune the stability of the display and the degree of reaction of the balance to the requirements of certain applications or the installation environment. There is a possibility of selection among five operating modes. Please note that in general slowing down reaction times result in higher stability of the set data handling, while speeding up reaction times have an influence on the stability deterioration. However, the balances of PBS/PBJ type are designed to ensure both properties i.e. fast reaction time and high stability.

13.1.1 Automatic mode

Select the menu element **22**:

The balance automatically and dynamically undertakes to optimally determine the average value during observation of load data. If there are not any special circumstances, this setting should always be used.

13.1.2 Filling mode

Select the menu element **23**:

This mode is suitable for weighing invariable liquid volumes. It is very susceptible to wind and vibration.

(When the filling mode is active, the  button makes it possible to switch over between 3 stability settings.)

13.1.3 Standard mode

Select the menu element **24**:

This mode is suitable for weighing in normal environment. The determination of the average value is fixed and is not subject to adaptation as in the automatic mode which is performed dynamically.

13.1.4 Antivibration mode

Select the menu element **25**:

This mode should be used if the balance is placed at a location where there are strong vibrations, and its readings fluctuate in automatic mode.

The balance reaction is deteriorated in a result of small changes of weight.

13.1.5 Antiwind mode

Select the menu element **26**:

This mode should be used if the balance is placed at a location where it is exposed to air currents which cause fluctuations of its readings in automatic mode.

This reaction is deteriorated even more than in the antivibration mode, but the weighing process is more stable.

13.2 Stability Detection Band

(up to 8 counts for verifiable, up to 64 counts for non verifiable models)

The band makes it possible to select conditions at which the balance should be considered as stable. If „1 count” is selected, and the reading (within counting the readings) remains constant, the balance is considered as stable and the → stability display is shown. The stability detection band can be set from 2 to 64 counts.

Select the menu element:

27	for	1 count
28		2 counts
29		4 counts
30		8 counts

13.3 Tracking

Tracking is the function which ensures to receive present value displaying in possible long period.

To ACTIVATE this function, select the menu element **34**.

To DEACTIVATE this function, select the menu element **35**.

14 Capacity display

This function displays a bar graph representation of the load on the weighing pan. This may be used to prevent sudden appearance of “oL” (overload) during measurement.

Select the menu element **11** in the menu overview to set the full range mode:

(1)



The bar located within the lower scale range indicates that the weight located on the scale pan is small. (1)

(2)



The bar approaching the upper scale range indicates that the weight located on the scale pan almost reaches the balance capacity. (2)

If the bar graph is not to be displayed, press the menu element **21**



15 Switch-over weighing unit

Press the  button several times to switch over the display between the activated units.





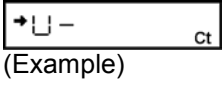

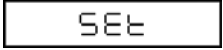
The default setting provides the following options:

[g] → [%] → [PCS] → [%]

Other settings must be activated in the menu as follows:

	<p>Menu overview No. 54 to 62 :</p> <p> Press button to switch over between the units.</p> <p>Save the selected unit using  button</p>
	<p>„SET“ appears shortly.</p> <p>The unit has been accepted.</p>

15.1 Percentage conversion

	<p>In weighing mode, press the  key repeatedly until the „%” symbol will be seen on the display.</p>
<p>Setting 100% of the reference value:</p>	
	<p>Press the  key to tare the balance.</p>
	<p>Put the reference sample which represents 100% value. This value must correspond to 100 or more counts in „g” unit.</p>
	<p>When the stabilisation display → appears, press the  key at once.</p>
	<p>„SET“ appears shortly.</p>
	<p>The reference sample weight will be shown as 100%.</p>
	<p>Weights of next samples will be displayed as a percent value of the reference sample weight.</p>

16 Application Functions

16.1 Parts counting

With parts counting you can either count parts into a container or remove parts from a container. To count a greater number of parts the average weight per part has to be determined with a small quantity (reference quantity). The larger the reference quantity, the higher the counting exactness. High reference must be selected for small parts or parts with considerably different sizes.

The process has four steps:

- Tare the weighing container
- Determine the reference unit
- Weigh in the reference unit
- Count the items

Condition: Activate the PCS function with the menu element **57** if it is not set. (The unit of PCS function is factory set.)

Make sure that the balance is in the weighing mode. (the unit of „g” is displayed)

Press the  button repeatedly until the „PCS” symbol is displayed.





Place the container on the balance plate and tare the balance with the  button.

Count exactly 9 (or 10, 20, 50, 100 or 200) pieces of the sample to be weighed and put them into the container.

Press  button.

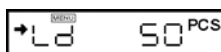
(Example)



Pressing the  button switches over display among the following symbols „Ld 5pcs”...„Ld 200pcs”, „Ld 5pcs”...

The standard setting is „Ld 10pcs”.

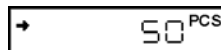

Press the  button when the display corresponds to the number of the pieces being put.

The reference quantity is saved.

16.2 Control weighing and target weighing

16.2.1 Control weighing (comparator) display type 1

It is the most suitable method which makes it possible to assess weighing courses or errors on the basis of the sample weight.

Select the menu element **15** in the menu overview.

Display elements used

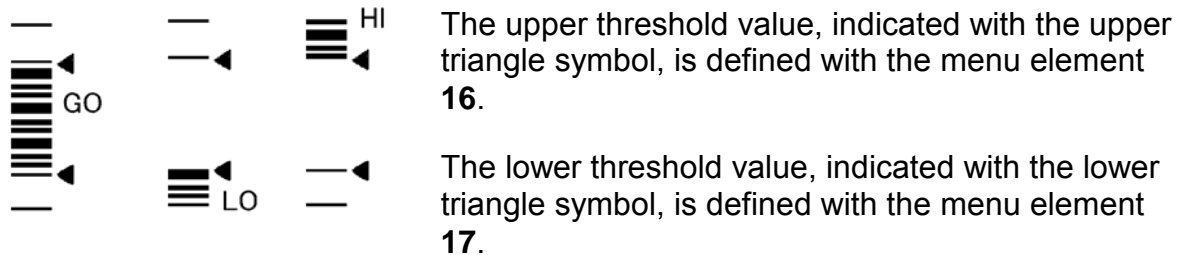

Note:

Determination is carried out in the following way:

Upper threshold value	< sample weight	HI
Lower threshold value	\leq sample weight \leq upper threshold value	GO
Sample weight	< lower threshold value	LO

16.2.2 Control weighing (comparator) – display type 2

This mode should be used for classifying on the basis of the sample weight. The display looks like a bar graph, but it also includes the control weighing function.

Select the menu element **18** in the menu overview.

Display elements used

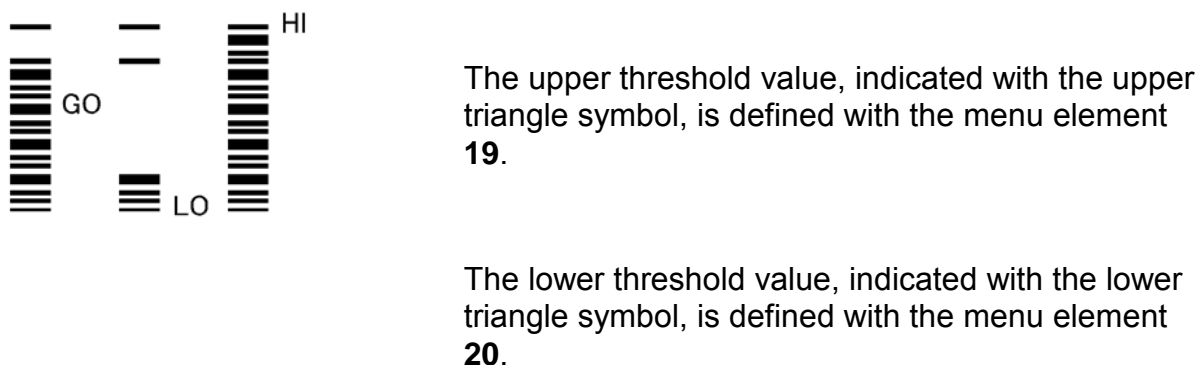

Note:

Determination is carried out in the following way:

Upper threshold value	< sample weight	HI
Lower threshold value	\leq sample weight \leq upper threshold value	GO
Sample weight	< lower threshold value	LO

16.2.3 Target weighing mode

This mode is used for weighing constant liquid quantities or for assessment of missing quantities or excess quantities.

The target value is the numeric value which corresponds to the nominal quantity of the used unit. The target value is a numerical value which corresponds to quantity of the set unit to be used for weighing. The target value on the analogue display is presented as the centre line. The limit values are indicated with the triangle symbols. The movable bar presents the current weight on the scale pan.

The target weighing mode is selected with the menu element **12**.

Display elements used

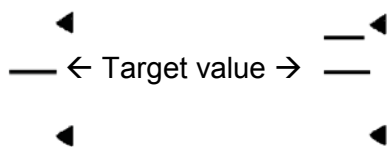

The „target value”, which corresponds to the centre line on the graphic display, is to be set with the menu element **13**.

Without load

With weight within
limit range

The „limit value”, which corresponds to the distance between the centre line and upper or lower triangle symbol, is to be set with the menu element **14**.





16.3 Density determination

16.3.1 Specific measurement of solid weight

In the case of specific measurement of solid weights, the sample (solid) weight is measured in air as well as in the liquid with known density and the sample density is calculated on the basis of that results. The ▼ symbol presents the solid density on this balance. Density determination with the help of the flush-mounted platform facility is described in the following.

Density determination becomes even easier when an optional set for density determination is applied. For further information please refer to the operating instructions enclosed with the set for density determination.

Select the menu element **60** in the menu overview.

- From the below table (chapter 16.3.2) enter the density value (g/cm^3) of the liquid (water, alcohol etc.) in which the sample is immersed. (Entering numerical values, refer to chapter 11.4, setting decimal point, refer to chapter 11.7). To write off the setting, zero the value.
- Remove the cover of the hook for underfloor weighing in the balance bottom.
- Attach the scale pan to be hung on the hook and immerse it in the container filled with the liquid with known density.
- Restore the weighing mode with the  button and repeatedly press the  key until the „▼d” (inverted triangle and „d”) symbol is displayed.
- Press the  button
- Place the sample on the weighing plate. (If necessary, the „dSP oL” symbol will be displayed, which does not indicate any disturbance.)
- When the → stabilisation display is illuminated, press  button.
- Place the sample on the scale pan to be hung. The density of the sample is shown.

Notes:

- 4 positions after the point is displayed for the specific weight. If it is not possible to stabilize the balance with all four positions after the point, use the 1d/10d switch over function (refer to chapter 12.8).
- If the sample lies on the scale pan immersed in the liquid, make sure that the whole sample is immersed in the liquid.
- The balance is not zeroed again if the  key is pressed within this function.

16.3.2 Table of temperatures and densities

Temperatur e [°C]	Density ρ [g/cm ³]		
	Water	Ethyl Alcohol	Methyl Alcohol
10	0.9997	0.7978	0.8009
11	0.9996	0.7969	0.8000
12	0.9995	0.7961	0.7991
13	0.9994	0.7953	0.7982
14	0.9993	0.7944	0.7972
15	0.9991	0.7935	0.7963
16	0.9990	0.7927	0.7954
17	0.9988	0.7918	0.7945
18	0.9986	0.7909	0.7935
19	0.9984	0.7901	0.7926
20	0.9982	0.7893	0.7917
21	0.9980	0.7884	0.7907
22	0.9978	0.7876	0.7898
23	0.9976	0.7867	0.7880
24	0.9973	0.7859	0.7870
25	0.9971	0.7851	0.7870
26	0.9968	0.7842	0.7861
27	0.9965	0.7833	0.7852
28	0.9963	0.7824	0.7842
29	0.9960	0.7816	0.7833
30	0.9957	0.7808	0.7824
31	0.9954	0.7800	0.7814
32	0.9951	0.7791	0.7805
33	0.9947	0.7783	0.7896
34	0.9944	0.7774	0.7886
35	0.9941	0.7766	0.7877



16.3.3 Specific measurement of liquid weight

In the case of specific measurement of liquid weight, the weight of reference solid with known volume is measured in air and the liquid to be tested. The specific liquid weight is calculated on the basis of those both values.

The display unit for the specific liquid weight is „d”.

Density determination becomes even easier when an optional set for density determination is applied. For further information please refer to the operating instructions enclosed with the set for density determination.

Select the menu element **61** in the menu overview.

- Enter the sinker density value.
- Remove the cover of the hook for underfloor weighing in the balance bottom.
- Attach the sinker on the hook and immerse it in the container filled with the liquid to be tested.
- Restore the weighing mode with the  button and press  button repeatedly until the „d” symbol is displayed.
- Place the sinker on the balance plate.
- When the → stabilisation display is illuminated, press  button. (If necessary, the „dSP oL” symbol will be displayed, which does not indicate any disturbance.)
- Place the reference weight on the scale pan and immerse it in the tested liquid. The specific weight of the tested liquid will be displayed.

Notes:

- 4 positions after the point is displayed for the specific weight. If it is not possible to stabilize the balance with all four decimal positions, use the 1d/10d switch over function (refer to chapter 14.1. gelöscht).
- If the reference weight lies on the weighing pan immersed in the liquid, make sure that the whole weight is immersed in the liquid.

16.4 Extreme value recording

(models with non-verifiable setting only)

The “extreme value” stands for the highest or lowest value indicated after a value alteration of more than fivefold the null region.

To determine the extreme value, choose menu item **49**.

16.5 Auto Print function

(models with non-verifiable setting only)

Using the Auto Print function ensures automatic data printing without necessity to

press the  button for each single measurement. If the function is activated, the **AP** (Auto-Print) symbol is displayed.

It is possible to select from six types of automatic printing. Information concerning setting the zero range can be found in chapter 11.7

Printing whilst loading:

Select the menu element **42** in the menu overview.

Place or remove the sample when the displayed value lies within the zero range. The data will be output automatically when the \rightarrow stabilisation symbol is illuminated and the displayed positive value exceeds 5 times the zero range value. The next data output will occur when the display is brought to the value within the zero range by

removing the sample or pressing the  button.

Printing whilst loading and unloading:

Select the menu element **43** in the menu overview.

Place or remove the sample when the displayed value lies within the zero range. The data will be output automatically when the \rightarrow stabilisation symbol is illuminated and the displayed positive or negative value exceeds 5 times the zero range value. The next data output will occur when the display is brought to the value within the zero

range by removing the sample or pressing the  button.

Printing whilst loading and at zero:

Select the menu element **44** in the menu overview.

Place or remove the sample when the displayed value lies within the zero range. The data will be output automatically when the \rightarrow stabilisation symbol is illuminated and the displayed positive value exceeds 5 times the zero range value. Remove the

sample or press the  button. The data will be output again when the displayed value lies within the zero range and the \rightarrow stabilisation symbol is illuminated.

Printing whilst loading, unloading and at zero:

Select the menu element **45** in the menu overview.

Place or remove the sample when the displayed value lies within the zero range. The data will be output automatically when the \rightarrow stabilisation symbol is illuminated and the displayed positive or negative value exceeds 5 times the zero range value.

Remove the sample or press the  button. The data will be output again when the displayed value lies within the zero range and the \rightarrow stabilisation symbol is illuminated.

16.6 Automatic zero setting

(models with non-verifiable setting only)

If the displayed value is within the zero range and the stability display lights up, zero setting occurs automatically. The zero symbol appears.

To switch-on the zero setting function, select menu symbol **41**



16.7 Zero range

The „zero range“ is used as a reference value, whether a sample was placed or not.

To determine the zero range, select the menu element **48** .

16.8 Taring /printing at stability (models PBJ)

(only in verifiable units)

Determine if the balance first has to reach stability before printing via the  button or the zero point can be displayed via the  button.

If you want to print or to tare without waiting for stability:

(immediate operation)

- Select the menu element **39**.

If printing or taring only after having reached stability: (waiting for stability)





- Select the menu element **40**.

Notes:

While the balance waits for stability, „----“ is displayed.

- Press  button, then „---“ appears.



At this opportunity press the  button, if you deactivate this function and want to cancel taring.

- If the communication  - and the standby STAND-BY symbol are illuminated and you press the  button, you have to wait for the stability symbol  . The data are output, when the stability symbol  is illuminated.







If during waiting time you press the  button, the balance goes to standby mode. Data are printed as soon as in the next weighing process stability has been reached.

16.9 Formulation mode

This mode is used for convenient weighing of individual recipe components.

Weights of each component are displayed and saved after each pressing the  button. The weights of those component are sent with the RS-232C or DATA I/O interface, and the display is automatically zeroed to weigh the next component. When all components are weighed, their weights are added up and the total weight is displayed. This value output is edited by the  button.









Select the menu element **51** in the menu overview.

- 1. If the recipe mode is activated, the display is in the recipe stand-by mode until it is started. The display shows the Add-On symbol, memory symbol and stand-by mode symbol. Place the container (if used) and press the  button to tare it. Please remember that taring with the  button will not be accepted after previous pressing the  button (as in the step 2). Taring is possible again after previous pressing the  button (as in the step 5).
- 2. Press the  button. If a peripheral device is connected, „----- FORMULATION MODE -----” will be emitted.
- 3. Place the first component and then press the  button. The weight value will be output as „CMP001”. After that, the display will be automatically zeroed.
- 4. Step 3 is to be repeated for all components to be weighed.
- 5. Then press the  button. The total weight will be displayed and output to peripheral devices with the „TOTAL=” unit.
- 6. Remove everything from the balance plate. The next recipe is started from the step 1.



16.10 Automatic saving and zeroing

This function is used for weighing large number of single samples. If the function is activated, the  automatic saving and zeroing symbol is illuminated.

Select the menu element **52** in the menu overview.

- Place the container to be weighed on the balance and press the  button when the automatic saving and zeroing function is in the stand-by mode. (The  automatic saving and zeroing symbol and STAND-BY mode symbol are illuminated.)
The balance will be zeroed.
- Press the  button. The stand-by symbol disappears and measurements within the automatic saving and zeroing function can be started.
- Place the first sample on the scale pan. Each time when the  stabilisation symbol is illuminated and the value corresponding to five times the zero range or higher is illuminated or when the  button is pressed, the illuminating value output and balance zeroing is carried out.
- Weighing process of the next sample is carried out without the necessity to press the  button.
- Press the  button. The balance returns to the stand-by mode of the automatic saving and zeroing function, the total weight placed on the scale pan without the packaging weight is displayed. To print this value, press the  button.

Notes:

- If the stabilisation symbol is illuminated and the display value lies within the zero range, zeroing is carried out automatically.
- Pressing the  button when the display value lies below five times the zero range is followed by zeroing after data output. (Manual loading)
- Pressing the  button when the automatic saving and zeroing function is in stand-by mode is also followed by setting mains supply in stand-by mode.

16.11 Animal weighing

(only possible with non verifiable setting)

This function is used for weighing animals. The animal symbol  is displayed when the animal weighing mode is active.

Select the menu element **53** in the menu overview.



- Place the weighing container on the scale pan and press the  button.

Note:

When the weighing container is placed on the scale pan, data output is possible. It is not a fault. This no malfunction.

- Place an animal on the scale pan. Its weight must exceed 50 times the zero range.
- The value will be given automatically when the weighing value is stabilised.
- Press the  button or remove an animal from the scale pan.
- If the displayed value is stable, but it lies below 10 times of the zero range, the balance will be zeroed automatically. Any remaining materials on the scale pan (excrement or skin) will be automatically written off and zeroed. If the balance is not zeroed, the zero range value must be increased (refer to chapter 10.7).

Notes:

- The stand-by mode is not provided for the animal weighing function.
- Press the  button to switch over to the mains supply stand-by mode.
- When live animals are weighed in the animal weighing mode, automatic extension of stability detection band is carried out. Repeatability of measuring data is a bit lower than in other operational modes.
- If an animal being weighed cannot be controlled and the automatic printing function does not respond, you can press the  button to output the display value. Then remove an animal from the balance. Even if the stability symbol appears before an animal is removed from the balance, the data will not be printed again.
- The stability symbol will appear earlier due to setting the wider stability detection band in the menu.
- If the balance returns to the zero point too slowly, the zero range is to be set to a higher value.
- The initial taring function (chapter 11.2.1) cannot be used together with the animal weighing function.

17 Data output

17.1 Personal Computer - RS-232C

17.1.1 Connecting the Cable

ATTENTION:

By using the RS-232C/AUX interface of the PBS/PBJ type balances it is also possible to output other signals than RS-232C ones. Incorrect connection of those signal cables may lead to the personal computer or balance failure. Therefore, make sure that the suitable and correctly connected cable provides communication between the balance and computer.

Some types of computers may not operate normally when they are connected by using the optional RS-232C cable in the way shown in the below figure.

(1) IBM PC/AT computer and compatible (9-pin D-sub connector)

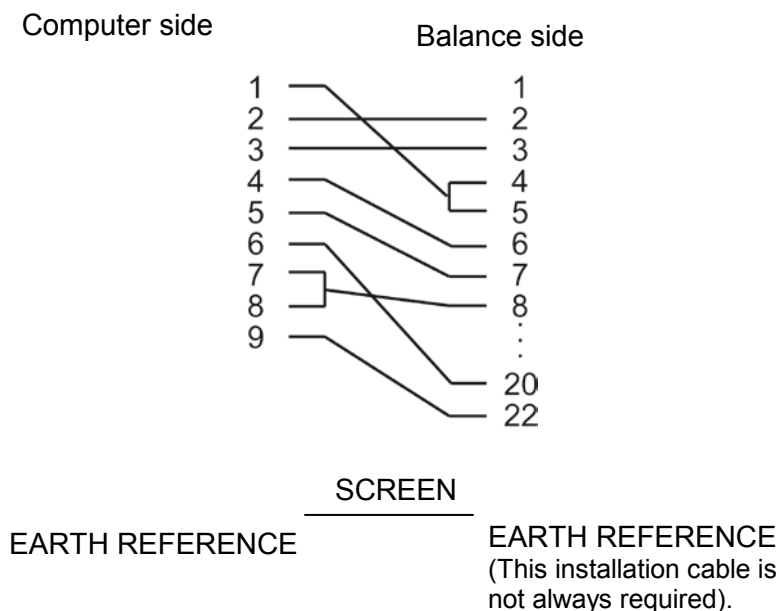

(2) IEEE standard (D-sub 25-pin)

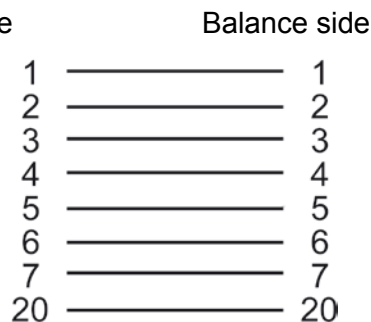

17.2 Data Formats

The following explanations refer to the case when the menu element **77** (EB type format) is selected. Explanations concerning other formats are included in the data of computers compatible with the suitable data formats.

Note:

The □ mark indicates the space code, and <Limiter> indicates the limiter code.

1. For measuring values:

First sign	Minus: '-' Not minus: space
from 2. to 11. sign:	Numerical values or „[“, ”]“ are right justified. Position of the decimal point is changed depending on the device type.
from 12. to 13. sign:	Units such as g□ or kg
from 14. to 15. sign:	Limiter

Note:

- If the CR or LF command is the limiter (the menu element **94** or **95** is selected), sign 13 is not available.
- When stability information is printed, the first of the above mentioned signs is preceded with the following sign:
Stable time: S
Instable time: D

2. For „oL“ or „-oL“

„oL“ □□□□ OL □□□□ < Limiter >
„-oL“ – □□□□ OL □□□□ < Limiter >

17.3 Using codes of commands

Note:

Incorrect setting of communication parameters results in displaying the communication error „ComErr”.

1. Commands ending with a digit, letter or symbol different than [=]:

commands to the balance must be transmitted with a limiter for each command code.

Example 1:

PRINT<CR> ... The same process as after pressing the



button.

2. Commands ending with the [=] sign: Digits must be transmitted with a limiter to the balance.

Example 2:

TIME=1234 <CR> .. The time of 12:34 is set as the current time

Example 3:

P.TARE=1.23 <CR> (example for two positions after the point).
The value of 1,23 g is set as the initial taring value.

Example 4:

P.TARE=0.00 <CR> (example for two positions after the point).
... cancels (writes off) the initial taring value.

Note:

Number of positions, decimal point and position of the decimal point in the number sign transmitted after the '=' sign are the same as they would be for entering numerical value with the buttonboard.

Use the same number of places after the point as in the weighing mode.

This limitation does not refer to USER=, SOLID= and LIQUID= commands.

Notes:

- If 0 is at the beginning of the four-position number, the setting is finished at this point, and the menu selection is finished.
- The result of such a command depends on the balance type.

Example 6: #=2.56 <CR>

Example 7: #=12.345.67 <CR>

A computer makes it possible to determine the specified presentation way of numbers for processes of weighing and displaying on the balance.

In the case of commands from examples 6 and 7, the values of [#2.56] and [#12.345.67] are displayed on the balance. When

the  button is pressed, the '2-56<CR>' and '12-345-67<CR>' strings are sent from the balance.

3. Return message command

The balance sends back the N string of signs which are limited by the return message command '{' or '}' and limiter.

In the receive buffer of the balance there are not left any not processed return message commands for $N \leq 30$.

Example 8: ABCDEFGH12345<CR>











... When this command is received, the balance sends ABCDEFGH12345<CR> string. This string can be printed by the printer.

Note:

Only capital letters and part of symbols (decimal point, decimal symbol etc.) can be used for data output with an electronic printer. Maximal length of line is 15 characters.

4. Codes of commands for EB type formats (the menu element 77) and Old EB type (menu element 78)**(i) Output commands**

D01	Continuous output
D03	Continuous output with stability information
D05	Single output
D06	Automatic printing setting (type of automatic printing is set separately)
D07	Single output with stability information
D09	Cancellation of continuous output and automatic printing

(ii) Commands concerning user buttons	
POWER	Corresponds to the  button.
Q	Corresponds to the  button.
MENU	Corresponds to the  button.
TARE	Corresponds to the  button.
T	Corresponds to the  button.
UNIT	Corresponds to the  button.
PRINT	Corresponds to the  button.
POWER*	Corresponds to holding the  button for about 3 seconds.
MENU+	Corresponds to holding the  button for about 3 seconds.
UNIT+	Corresponds to holding the  button for about 3 seconds.
PRINT+	Corresponds to holding the  button for about 3 seconds.

(iii) Commands concerning user measurements	
ADDON	Sets automatic saving and zeroing mode.
+	Comes into use immediately after setting the automatic saving and zeroing mode.
A	Sets animal weighing mode.
ANIMAL	Sets animal weighing mode.
R	Cancels user weighing mode.

(iv) Commands concerning conversion of units	
g	Switches over to „g” unit.
kg	Registration of „kg” unit and switching over.
PERCENT	Registration of „%” unit and switching over.
%	Sets 100% when displaying is carried out in „%” unit.
G	g - % switching over.
PCS	Registration of „PCS” unit and switching over.
SDENSE	Registration of „Solid density” unit and switching over.
LDENSE	Registration of „Liquid density” unit and switching over.
RSTUNIT	Return to the standard settings.

(v) Reading commands for set values	
TARGET	Readout of the set target value.
LIMIT	Readout of the set limit value.
G.LO	Readout of the set lower limit value on the display of the check weighing 1.
G.UP	Readout of the set upper limit value on the display of the check weighing 1.
L.LO	Readout of the set lower limit value on the display of the check weighing 2.
L.UP	Readout of the set upper limit value on the display of the check weighing 2.
UW	Readout of the set value for weight unit.
G/PCS	Corresponds to the „g/PCS” button.
CALWIT	Readout of the set external weight value for calibration of measuring range.
ACALT1	Readout of time 1 in the Clock-CAL mode.
ACALT2	Readout of time 2 in the Clock-CAL mode.
ACALT3	Readout of time 3 in the Clock-CAL mode.
P.TARE	Readout of the set initial taring value.
ZRNG	Readout of the set zero range value.
USER	Readout of conversion factors for the user unit.
VOL	Readout of the set value for reference weight.
DENSE	Readout of the set value for ambient liquid density.
ITIME	Readout of the set value for interval timer.

(vi) Commands for setting numerical values	
CALWIT=	Sets external weight value for calibration of measuring range.
ACALT1=	Sets time 1 in the Clock-CAL mode.
ACALT2=	Sets time 2 in the Clock-CAL mode.
ACALT3=	Sets time 3 in the Clock-CAL mode.
UW=	Sets weight unit.
VOL=	Sets volume of reference weight.
SDENSE=	Sets density of ambient liquid.
DATE=	Sets date.
TIME=	Sets time.
TARGET=	Sets target value.
LIMIT	Sets limit value.
G.LO=	Sets lower limit value on the display of the check weighing 1.
G.UP=	Sets upper limit value on the display of the check weighing 1.
L.LO=	Sets lower limit value on the display of the check weighing 2.
L.UP=	Sets upper limit value on the display of the check weighing 2.
PCS=	Sets any number of pieces.
#=	Corresponds to numeric buttons of the keyboard.
ID=	Specifies ID.

(vii) Commands of special functions	
CAL	Calls up measuring range calibration mode.
C18	Calls up measuring range calibration mode.
LOCK	Sets menu lockout.
RELEASE	Releases menu lockout.
TIME	Reads date and time.
ADJCLK	Carries out correction by ± 30 seconds.
RSTMN	Resetting the menu
MENU=	Makes it possible to call up any menu.
{	Return message.
}	Return message.
[@]	Switches over to the multipoint connection mode. (@ for lower case letters)

5. Commands compatible with Mettler Toledo series electronic balances	
S	Single output in stable condition
SI	Immediate, single output
SIR	Continuous output
SR	Continuous output in stable condition
T	Taring after stabilisation
TI	Immediate taring
Z	Zeroing (the same as immediate taring)

5. Commands compatible with Sartorius series electronic balances	
<ESC>P	Single taring
<ESC>T	Taring

Note:

<ESC> for escape code (1BH)

17.4 User Settings

17.4.1 Overview

This menu is used to determine technical data of communication between the balance and a computer or electronic printer.

Note:

This menu applies both to the RS-232C interface and DATA I/O interface. For the device to which the DATA I/O interface is connected e.g. electronic printer, the balance communication parameters should be set to the standard settings i.e. select the following menu elements: **76, 77, 83, 89, 92, 94**.

17.4.2 Handshaking

The handshake function determines whether or not peripheral devices can receive communication data from the balance. It does not transfer the balance status to the peripheral devices. The balance can receive data as long as there is a free space in its receive buffer memory. This function is ready for operation when the „OFF” symbol is displayed. Its reliable operation in other states cannot be guaranteed.

If the balance data output is interrupted by the handshake function, the balance display is locked.

Enter the suitable settings for the handshake function.

If the software handshake function is not to be performed, select the menu element	73
If the software handshake function is to be performed in the way described below, select the menu element	74
<ul style="list-style-type: none"> • When the X-OFF (13H) command is received by the balance, the balance data output is stopped. • When the X-ON (11H) command is received by the balance, the balance data output is started. 	
If the hardware handshake function is to be performed in the way described below, select the menu element	75
<ul style="list-style-type: none"> • If the DTR parameter is set to OFF, the balance data output is stopped. • If the DTR parameter is set to ON, the balance data output is started. 	
To call up the time controlled hardware handshake function, select the menu element	76

17.4.3 Format

Specify the format of data output by the balance.

For the standard format of the KERN electronic balances

- Select menu element **77** .

For the old data output format of the KERN electronic balances:

- Select menu element **78** .

17.4.4 Speed of communication

Specify the transmission speed (300, 600, 1200, 2400, 4800, 9600, 19200 or 38400 bps).

The value presented as „b-xxx” gives the number of bps (bits/second). Baud-rate and bps are the same value.

Select one of the menu elements from **81** to **88**.

17.4.5 Parity / Bit length

Select the parity and bit length.

No parity, 8-bit length: Select the menu element **89**

Odd parity, 7-bit length: Select the menu element **90**

Straight parity, 7-bit length: Select the menu element **91**

17.4.6 Stop Bits

Select the number of stop bits.

Stop bit 1: Select the menu element **92**

Stop bit 2: Select the menu element **93**

17.4.7 Limiter

The „limiter” is used to separate single data or commands from each other. The limiter is to be set in the following way:

Setting to CR(0DH): Select the menu element **94**

Setting to LF(0AH): Select the menu element **95**

Setting to CR+LF(0D0AH): Select the menu element **96**

18 Service, maintenance, disposal

18.1 Clean

Before cleaning, please disconnect the appliance from the operating voltage.

Please do not use aggressive cleaning agents (solvents or similar agents), but a cloth dampened with mild soap suds. Ensure that no liquid penetrates into the device and wipe with a dry soft cloth.

Loose residue sample/powder can be removed carefully with a brush or manual vacuum cleaner.

Spilled weighing goods must be removed immediately.

18.2 Service, maintenance

The appliance may only be opened by trained service technicians who are authorized by KERN.

Before opening, disconnect from power supply.

18.3 Disposal

Disposal of packaging and appliance must be carried out by operator according to valid national or regional law of the location where the appliance is used.

19 Instant help

In case of an error in the program process, briefly turn off the balance and disconnect from power supply. The weighing process must then be restarted from the beginning.

General display:

Display	Explication
---	Wait for the next display.
-t ime-	Date and time are output.
Abort	The process has been interrupted.
RPL End	Operational measurement is allowed.
d ouEr	Too large error was found during calibration check. (Please contact your sales representative.)
d UndEr	Too large error was found during calibration check. (Please contact your sales representative.)
LoCKEd	Menu lock active
rELERSE	Menu lockout released.
rESEt	The menu has been reset.
SEt	The contents of the new setting and factor have been saved.
oFF	Return in a result of mains failure.
wR it	The built-in weight is moving. Please wait.
All number signs are flashing.	Put the calibration weight being displayed.

Error message:**Displayed error code****Explication****Remedy**

CAL E0

Disturbances in weight loading mechanical elements.

Check transport screws.

CAL E1

Weight on the scale pan is unstable during calibration.

CAL E2

Large zero point drift during calibration.

Empty the scale pan.

CAL E3

Large drift during the PCAL function.

Use the correct weight.

CAL E4

Large drift during calibration of the measuring range.

Use the correct weight.

CAL E5

Calibration weight is incorrect.

Use the correct weight.

CHE x

Disturbances in the balance (the balance is stopped when this display appears). *

ComErr

Received command code is incorrect.

Check limiters etc.

dSP oL

Total number of the displayed unit is longer than 7 positions.

Reduce load.

Err 0x

Disturbance in the balance.

*

Err 24

The power voltage is incorrect.

Check the power voltage .

* Please contact your sales representative.

Fault finding Procedures:

Symptom	Possible cause	Remedy
Display is empty.	<ul style="list-style-type: none">• Mains adapter is not connected.• The room mains circuit-breaker is switched off.• Incorrect voltage.	Check mains voltage and connect the mains adapter correctly.
„OL” or „-OL” display	The transport screws are not locked. Pads of the scale pan not installed. Too large weight on the scale pan.	Turn the screws anticlockwise until they are locked. Install pads of the scale pan. Use the weight within its capacity.
The display does not react after putting a weight on the scale pan.	The weighing pan is displaced.	Place the weighing pan correctly.
The display fluctuates.	Influence of vibrations or air flow. Protective shield is touching the scale pan.	Place the weight at the suitable location. Try to change environment settings. Install the shield on the main unit of the balance.
Incorrect weighing result.	Calibration of the measuring range is not effective. Taring is not effective.	Calibrate the balance correctly Tare the balance before weighing.
The balance does not display the required unit.	The unit has not been set.	First set the unit.
Selection of the menu element is rejected.	Menu lock ACTIVATED.	Remove the menu lock