



Incubator

IN75

The incubator I is at home everywhere in the world of research, medicine, pharmaceuticals and food analytics, as well as food chemistry.



The heating of this incubator is optimally tuned for both natural convection and forced air circulation; the fan can also be switched off completely, and valuable chamber loads for research, pharmaceuticals, medicine and food chemistry are warmed up very carefully.

On this page, you can find all the essential technical data on our incubator. Our customer relations team will be pleased to help if you want further information. If you should require a customised special solution, please contact our technical specialists at myAtmoSAFE@memmert.com.

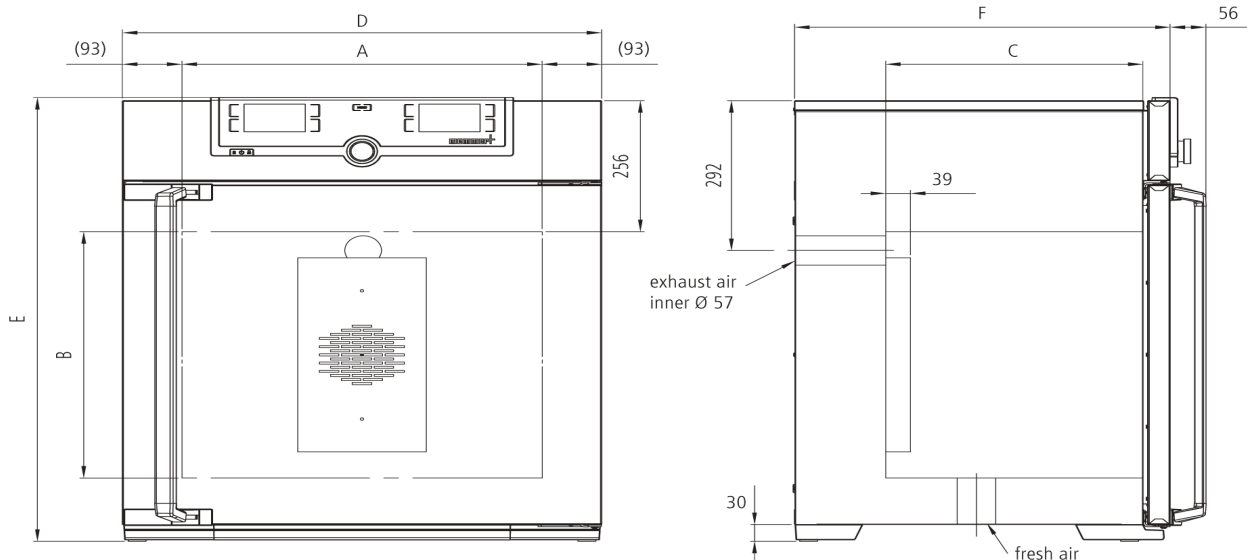

Temperature

Set temperature range in °C min. 5°C above ambient up to +80°C

Setting accuracy temperature 0.1°C

Temperature 1 Pt100 sensor DIN class A in 4-wire-circuit

Control technology

Language setting German, English, Spanish, French, Polish, Czech, Hungarian

ControlCOCKPIT SingleDISPLAY. Adaptive multifunctional digital PID-microprocessor controller with high-definition TFT-colour display

Timer Digital backwards counter with target time setting, adjustable from 1 minute to 99 days

Function SetpointWAIT the process time does not start until the set temperature is reached

Calibration three freely selectable temperature values

adjustable parameters temperature (Celsius or Fahrenheit), air flap position, programme time, time zones, summertime/wintertime

Ventilation

Convection natural convection

Fresh air admixture adjustment of pre-heated fresh air admixture by air flap control in 10 % steps

Vent vent connection with restrictor flap

Communication

Documentation programme stored in case of power failure

Programming AtmoCONTROL software for reading out, managing and organising the data logger via Ethernet interface (temporary trial version can be downloaded). USB stick with AtmoCONTROL software available as accessory (on demand).

Safety

Temperature control adjustable electronic overtemperature monitor and mechanical temperature limiter TB, protection class 1 according to DIN 12880 to switch off the heating approx. 20°C above nominal temperature

Autodiagnostic system for fault analysis

Standard equipment

Works calibration certificate incl. works calibration certificate for +37°C

Door fully insulated stainless steel door with 2-point locking (compression door lock)

Door inner glass door

Internals 2 stainless steel grids

Stainless steel interior

Interior	easy-to-clean interior,made of stainless steel, reinforced by deep drawn ribbing with integrated and protected large-area heating on four sides
Volume	74 l
Dimensions W x H x D in mm	$w_{(A)} \times h_{(B)} \times d_{(C)}$: 400 x 560 x 330 mm
Max. number of internals	6
Max. loading of chamber	120 kg
Max. loading per internal	20 kg

Textured stainless steel casing

Dimensions	$w_{(D)} \times h_{(E)} \times d_{(F)}$: 585 x 944 x 514 mm
Housing	rear zinc-plated steel

Electrical data

Voltage	230 V, 50/60 Hz
Electrical load	approx. 1250 W
Voltage	115 V, 50/60 Hz
Electrical load	approx. 900 W

Packing/shipping data

the appliances must be transported upright

Customs tariff number	8419 8998
Country of origin	Federal Republic of Germany
WEEE-Reg.-No.	DE 66812464
Dimensions approx incl. carton	B x H x T: 730 x 1130 x 670 mm
Net weight	approx. 66 kg
Gross weight carton	approx. 85 kg

Standard units are safety-approved and bear the test marks

