

Operating Manual

M (E2)

Drying and heating ovens with forced convection
and advanced program functions

Model	Model version	Art. No.
M 53	M053-230V	9010-0201, 9110-0201
M 115	M115-230V	9010-0202, 9110-0202
M 240	M240-230V	9010-0203, 9110-0203
M 400	M400-230V	9010-0204, 9110-0204
M 720	M720-230V	9010-0205, 9110-0205

BINDER GmbH

- ▶ Address: Post office box 102, 78502 Tuttlingen, Germany ▶ Phone: +49 7462 2005 0
- ▶ Fax: +49 7462 2005 100 ▶ Internet: <http://www.binder-world.com>
- ▶ E-mail: info@binder-world.com ▶ Service Hotline: +49 7462 2005 555
- ▶ Service Fax: +49 7462 2005 93 555 ▶ Service E-Mail: service@binder-world.com
- ▶ Service Hotline USA: +1 866 885 9794 or +1 631 224 4340 x3
- ▶ Service Hotline Asia Pacific: +852 390 705 04 or +852 390 705 03
- ▶ Service Hotline Russia and CIS: +7 495 988 15 16

Contents

1. SAFETY	4
1.1 Legal considerations	4
1.2 Structure of the safety instructions.....	4
1.2.1 Signal word panel	4
1.2.2 Safety alert symbol	5
1.2.3 Pictograms	5
1.2.4 Word message panel structure.....	6
1.3 Localization / position of safety labels on the chamber	6
1.4 Type plate	7
1.5 General safety instructions on installing and operating the chambers	8
1.6 Intended use	9
2. CHAMBER DESCRIPTION	10
2.1 Chamber overview	11
2.2 Control panel.....	12
3. COMPLETENESS OF DELIVERY, TRANSPORTATION, STORAGE, AND INSTALLATION	12
3.1 Unpacking, and checking equipment and completeness of delivery.....	12
3.2 Guidelines for safe lifting and transportation	13
3.3 Storage.....	13
3.4 Location of installation and ambient conditions	14
4. INSTALLATION AND CONNECTIONS	15
4.1 Electrical connection	15
4.2 Connection to a suction plant (optional)	15
5. START UP	16
5.1 Function overview of the MB1 display program controller.....	16
5.2 Operating modes.....	16
5.3 Performance after power failures.....	17
5.4 Turning on the chamber.....	17
6. CONTROLLER MB1 SETTINGS	18
6.1 Selection of the menu language	18
6.2 Overview of program controller MB1 displays	19
6.3 Menu settings in the “User-settings” menu	20
6.4 Menu settings in the “User Level” menu	21
7. GRAPHIC REPRESENTATION OF THE HISTORICAL MEASUREMENT (CHART RECORDER FUNCTION)	22
7.1 Setting the storage rate.....	24
8. MANUAL MODE	25
8.1 Entering the set point values.....	25
8.2 Performance after power failure in Manual Mode.....	26
9. PROGRAM OPERATION	26
9.1 Menu-based program entry.....	27
9.2 Selecting between set-point ramp and set-point step.....	29
9.3 Program entry as set-point ramp or as set-point step	29
9.4 Information on programming different temperature transitions.....	32
9.5 Repetition of a section or several sections within a program	33
9.6 Performance after power failure in Program Mode.....	33



9.7	Starting a previously entered program.....	34
9.8	Deleting a program.....	34
9.9	Temperature profile template.....	35
9.10	Program table template.....	36
10.	TEMPERATURE SAFETY DEVICES.....	37
10.1	Temperature safety device class 2 (DIN 12880)	37
10.2	Temperature safety device class 3.1 (DIN 12880) (available via BINDER INDIVIDUAL customized solutions).....	38
11.	OPTIONS.....	39
11.1	APT-COM™ 4 Multi Management Software (option).....	39
11.2	Ethernet interface.....	39
11.3	HEPA fresh air filter (option)	39
11.4	Data logger kit (option).....	40
11.5	Additional flexible Pt100-temperature sensor (option).....	40
11.6	Analog output for temperature (option).....	40
11.7	Additional measuring channel for digital object temperature indicator with flexible temperature sensor Pt 100 (option).....	41
11.8	Mostly gas-tight version (option for M 53 and M 115)	41
11.9	Inert gas connection with mostly gas-tight version (option for M 53 and M 115)	42
11.10	Keyboard locking (option)	44
12.	MAINTENANCE, CLEANING, AND SERVICE	44
12.1	Maintenance intervals, service.....	44
12.2	Cleaning and decontamination	45
12.2.1	Cleaning.....	45
12.2.2	Decontamination.....	47
12.3	Sending the chamber back to BINDER GmbH	48
13.	DISPOSAL.....	48
13.1	Disposal of the transport packing	48
13.2	Decommissioning.....	49
13.3	Disposal of the chamber in the Federal Republic of Germany	49
13.4	Disposal of the chamber in the member states of the EU except for the Federal Republic of Germany	50
13.5	Disposal of the chamber in non-member states of the EU	51
14.	TROUBLESHOOTING	52
15.	TECHNICAL DESCRIPTION.....	53
15.1	Factory calibration and adjustment.....	53
15.2	Definition of usable volume	53
15.3	Over current protection	54
15.4	Technical data.....	54
15.5	Equipment and options (extract).....	56
15.6	Accessories and spare parts (extract)	57
15.7	Dimensions M 53	58
15.8	Dimensions M 115	59
15.9	Dimensions M 240	60
15.10	Dimensions M 400	61
15.11	Dimensions M 720	62
16.	EU DECLARATION OF CONFORMITY	63
17.	PRODUCT REGISTRATION	65
18.	CONTAMINATION CLEARANCE CERTIFICATE	66
18.1	For chambers located outside the USA and Canada	66
18.2	For chambers located in the USA and Canada	69

Dear customer,

For the correct operation of the chambers, it is important that you read this operating manual completely and carefully and observe all instructions as indicated. Failure to read, understand and follow the instructions may result in personal injury. It can also lead to damage to the chamber and/or poor equipment performance.

1. Safety

This operating manual is part of the components of delivery. Always keep it handy for reference. The device should only be operated by laboratory personnel especially trained for this purpose and familiar with all precautionary measures required for working in a laboratory. Observe the national regulations on minimum age of laboratory personnel. To avoid injuries and damage observe the safety instructions of the operating manual.

	 WARNING
	<p>Failure to observe the safety instructions. may result in serious injuries and chamber damage.</p> <ul style="list-style-type: none"> ➤ Observe the safety instructions in this operating manual. ➤ Carefully read the complete operating instructions of the chambers.

1.1 Legal considerations

This operating manual is for informational purposes only. It contains information for installing, start-up, operation and maintenance of the product. Note: the contents and the product described are subject to change without notice.

Understanding and observing the instructions in this operating manual are prerequisites for hazard-free use and safety during operation and maintenance. In no event shall BINDER be held liable for any damages, direct or incidental arising out of or related to the use of this manual.

This operating manual cannot cover all conceivable applications. If you would like additional information, or if special problems arise that are not sufficiently addressed in this manual, please ask your dealer or contact us directly by phone at the number located on page one of this manual

Furthermore, we emphasize that the contents of this operating manual are not part of an earlier or existing agreement, description, or legal relationship, nor do they modify such a relationship. All obligations on the part of BINDER derive from the respective purchase contract, which also contains the entire and exclusively valid statement of warranty administration. The statements in this manual neither augment nor restrict the contractual warranty provisions.

1.2 Structure of the safety instructions

In this operating manual, the following safety definitions and symbols indicate dangerous situations following the harmonization of ISO 3864-2 and ANSI Z535.6.

1.2.1 Signal word panel

Depending on the probability of serious consequences, potential dangers are identified with a signal word, the corresponding safety color, and if appropriate, the safety alert symbol.

 DANGER
<p>Indicates an imminently hazardous situation that, if not avoided, will result in death or serious (irreversible) injury.</p>

WARNING

Indicates a potentially hazardous situation which, if not avoided, could result in death or serious (irreversible) injury

CAUTION

Indicates a potentially hazardous situation which, if not avoided, may result in moderate or minor (reversible) injury.

CAUTION

Indicates a potentially hazardous situation which, if not avoided, may result in damage to the product and/or its functions or of a property in its proximity.

1.2.2 Safety alert symbol





Use of the safety alert symbol indicates a **risk of injury**.

Observe all measures that are marked with the safety alert symbol in order to avoid death or injury.

1.2.3 Pictograms

Warning signs			
Electrical hazard	Hot surface	Explosive atmosphere	Stability hazard
Lifting hazard	Suffocation hazard	Pollution Hazard	Risk of corrosion and / or chemical burns
Biohazard	Harmful substances		
Mandatory action signs			
Mandatory regulation	Read operating instructions	Disconnect the power plug	Lift with several persons
Lift with mechanical assistance	Environment protection	Wear protective gloves	Wear safety goggles

Prohibition signs			
 Do NOT touch	 Do NOT spray with water		

	Information to be observed in order to ensure optimum function of the product.
---	---



1.2.4 Word message panel structure

<p>Type / cause of hazard.</p> <p>Possible consequences.</p> <ul style="list-style-type: none"> ⊖ Instruction how to avoid the hazard: prohibition ➤ Instruction how to avoid the hazard: mandatory action
--

Observe all other notes and information not necessarily emphasized in the same way, in order to avoid disruptions that could result in direct or indirect injury or property damage.

1.3 Localization / position of safety labels on the chamber

The following labels are located on the chamber:

Pictograms (Warning signs)	Service label
 <p>Hot surface</p> <ul style="list-style-type: none"> • Outer chamber door • On the chamber rear next to the exhaust duct 	 <p>Service - Hotline</p> <p>International: + 49 (0) 7462 / 2005-555 USA Toll Free: + 1 866 885 9794 or: + 1 631 224 4340 Россия и СНГ: + 7 495 98815 17</p> <p>serv.ce@binder-world.com www.binder-world.com</p> 

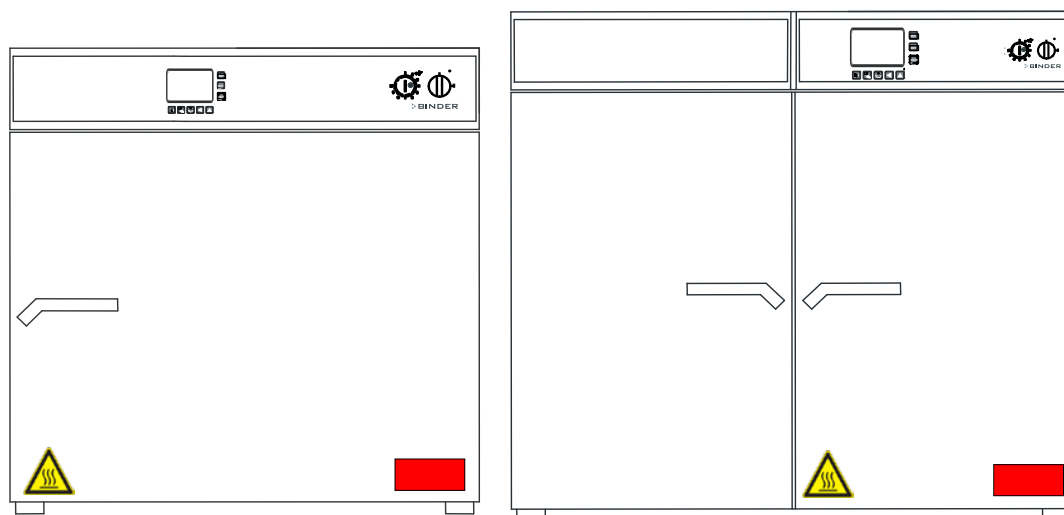



Figure 1: Position of labels on the chamber front

	Keep safety labels complete and legible.
---	---

Replace safety labels that are no longer legible. Contact BINDER service for these replacements.



1.4 Type plate

The type plate sticks to the left side of the chamber, bottom right-hand.

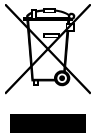

Figure 2: Type plate (example of M 115 regular chamber)

Indications of the type plate (example)		Information
BINDER		Manufacturer BINDER GmbH
M 115		Model designation
Drying and heating oven		Chamber name
Serial No.	000000000000	Serial no. of the chamber
Built	2017	Year of construction
Nominal temperature	300 °C 572 °F	Nominal temperature
IP protection	20	IP type of protection acc. to EN 60529
Temp. safety device	DIN 12880	Temperature safety device acc. to standard DIN 12880
Class	2.0	Class of temperature safety device
Art. No.	9010-0202	Art. no. of the chamber
Project No.	---	Optional: Special application acc. to project no.
1,60 kW		Nominal power
230 V 1 N ~		Nominal voltage ± 10%, phase indication
7,0 A		Nominal current
50/60 Hz		Power frequency

Symbol on the type plate (example)	Information
	CE conformity marking
	Electrical and electronic equipment manufactured / placed on the market in the EU after 13 August 2005 and to be disposed of in a separate collection according to directive 2012/19/EU on waste electrical and electronic equipment (WEEE).
	The chamber is certified according to Customs Union Technical Regulation (CU TR) for the Eurasian Economic Union (Russia, Belarus, Armenia, Kazakhstan Kyrgyzstan).

1.5 General safety instructions on installing and operating the chambers



With regard to operating the chambers and to the installation location, please observe the DGUV guidelines 213-850 on safe working in laboratories (formerly BGI/GUV-I 850-0, BGR/GUV-R 120 or ZH 1/119, issued by the employers' liability insurance association) (for Germany).

BINDER GmbH is only responsible for the safety features of the chamber provided skilled electricians or qualified personnel authorized by BINDER perform all maintenance and repair, and if components relating to chamber safety are replaced in the event of failure with original spare parts.



To operate the chamber, use only original BINDER accessories or accessories from third-party suppliers authorized by BINDER. The user is responsible for any risk caused by using unauthorized accessories.

	CAUTION
	<p>Danger of overheating.</p> <p>Damage to the chamber.</p> <ul style="list-style-type: none"> ⊙ Do NOT install the chamber in unventilated recesses. ➤ Ensure sufficient ventilation for dispersal of the heat.

Do not operate the chambers in hazardous locations.



	 DANGER
	<p>Explosion hazard.</p> <p>Danger of death.</p> <ul style="list-style-type: none"> ⊙ Do NOT operate the chamber in potentially explosive areas. ⊙ KEEP explosive dust or air-solvent mixtures AWAY from the chamber.

The chambers do not dispose of any measures of explosion protection.

	 DANGER
	<p>Explosion hazard.</p> <p>Danger of death.</p> <ul style="list-style-type: none"> ⊙ Do NOT introduce any substance into the chamber which is combustible or explosive at working temperature. ⊙ NO explosive dust or air-solvent mixture in the inner chamber.



Any solvent contained in the charging material must not be explosive or inflammable. I.e., irrespective of the solvent concentration in the steam room, NO explosive mixture with air must form. The temperature inside the chamber must lie below the flash point or below the sublimation point of the charging material. Familiarize yourself with the physical and chemical properties of the charging material, as well as the contained moisture constituent and its behavior with the addition of heat energy.

Familiarize yourself with any potential health risks caused by the charging material, the contained moisture constituent or by reaction products that may arise during the temperature process. Take adequate measures to exclude such risks prior to putting the chamber into operation.

	 DANGER
	<p>Electrical hazard. Danger of death.</p> <p>⊙ The chamber must NOT become wet during operation or maintenance.</p>

The chambers were produced in accordance with VDE regulations and were routinely tested in accordance to VDE 0411-1 (IEC 61010-1).

During and shortly after operation, the temperature of the inner surfaces almost equals the set-point.

	 CAUTION
	<p>The inner chamber, the door gasket, and the exhaust duct will become hot during operation.</p> <p>Danger of burning.</p> <p>⊙ Do NOT touch the inner surfaces, the door gasket, the exhaust duct or the charging material during operation.</p>

1.6 Intended use

Drying and heating ovens with forced convection and advanced program functions M are suitable for drying and heat treatment of solid or pulverized charging material, as well as bulk material, using the supply of heat. They can be used for drying purposes but are specially designed for solving all the problems which occur during material and ageing tests.

The chambers are suitable for harmless materials. A mixture of any component of the charging material with air must NOT be explosive. The operating temperature must lie below the flash point or below the sublimation point of the charging material. Any component of the charging material must NOT be able to release toxic gases.

Other applications are not approved.

The chambers are not classified as medical devices as defined by the Medical Device Directive 93/42/EEC.



Do NOT use the chambers for drying processes when large quantities of vapor would form and result in condensation.

	<p>Due to the special demands of the Medical Device Directive (MDD), these chamber are not qualified for sterilization of medical devices as defined by the directive 93/42/EEG.</p>
---	--

	<p>Following the instructions in this operating manual and conducting regular maintenance work (chap. 12) are part of the intended use.</p>
---	---

	<p>The charging material shall not contain any corrosive ingredients that may damage the machine components made of stainless steel, aluminum, and copper. Such ingredients include in particular acids and halides. Any corrosive damage caused by such ingredients is excluded from liability by BINDER GmbH.</p>
---	---

The chambers do not dispose of any measures of explosion protection.

 	 DANGER
<p>Explosion or implosion hazard.</p> <p>Danger of poisoning.</p> <p>Danger of death.</p> <ul style="list-style-type: none"> ∅ Do NOT introduce any substance combustible or explosive at working temperature into the chamber, in particular no energy sources such as batteries or lithium-ion batteries ∅ NO explosive dust or air-solvent mixture in the inner chamber. ∅ Do NOT introduce any substance which could lead to release of toxic gases. 	

In case of foreseeable use of the chamber there is no risk for the user through the integration of the chamber into systems or by special environmental or operating conditions in the sense of EN 61010-1:2010. For this, the intended use of the chamber and all its connections must be observed.

2. Chamber description

The drying and heating ovens with forced convection and advanced program functions APT.line™ M are specially developed precision warming chamber with high capacity. They are equipped with a multifunctional microprocessor display controller with a digital display accurate to one-tenth of a degree. With their comprehensive program control functions, they allow the high precision performance of temperature cycles with fast heating-up phases.

The APT.line™ preheating chamber system guarantees high level of spatial and time-based temperature precision, thanks to the direct and distributed air circulation into the interior. The fan supports exact attainment and maintenance of the desired temperature accuracy.

The high-quality housing insulation ensures both a low noise mode of operation and a consistently low housing temperature. The inner chamber, the pre-heating chamber and the interior side of the doors are all made of stainless V2A (German material no. 1.4301, US equivalent AISI 304). When operating the chamber at temperatures above 150 °C / 302 °F, the impact of the oxygen in the air may cause discoloration of the metallic surfaces (yellowish-brown or blue) by natural oxidation processes. These colorations are harmless and will in no way impair the function or quality of the chamber. The housing is RAL 7035 powder-coated. All corners and edges are also completely coated.

All chamber functions are easy and comfortable to use thanks to their clear arrangement. Major features are easy cleaning of all chamber parts and avoidance of undesired contamination.

The chambers are equipped with a serial interface RS 422 for computer communication, e.g. with the APT-COM™ 4 Multi Management Software (option, chap. 11.1) For further options, see chap. 15.4.

The M 720 model is equipped with four castors. Both front castors can be easily locked via the attached brakes.

At an ambient temperature of +18 °C up to +40 °C / 64.4 °F to 104 °F, you can operate the chamber in a temperature range from 5 °C / 9 °F above ambient temperature up to 300 °C / 572 °F.

2.1 Chamber overview

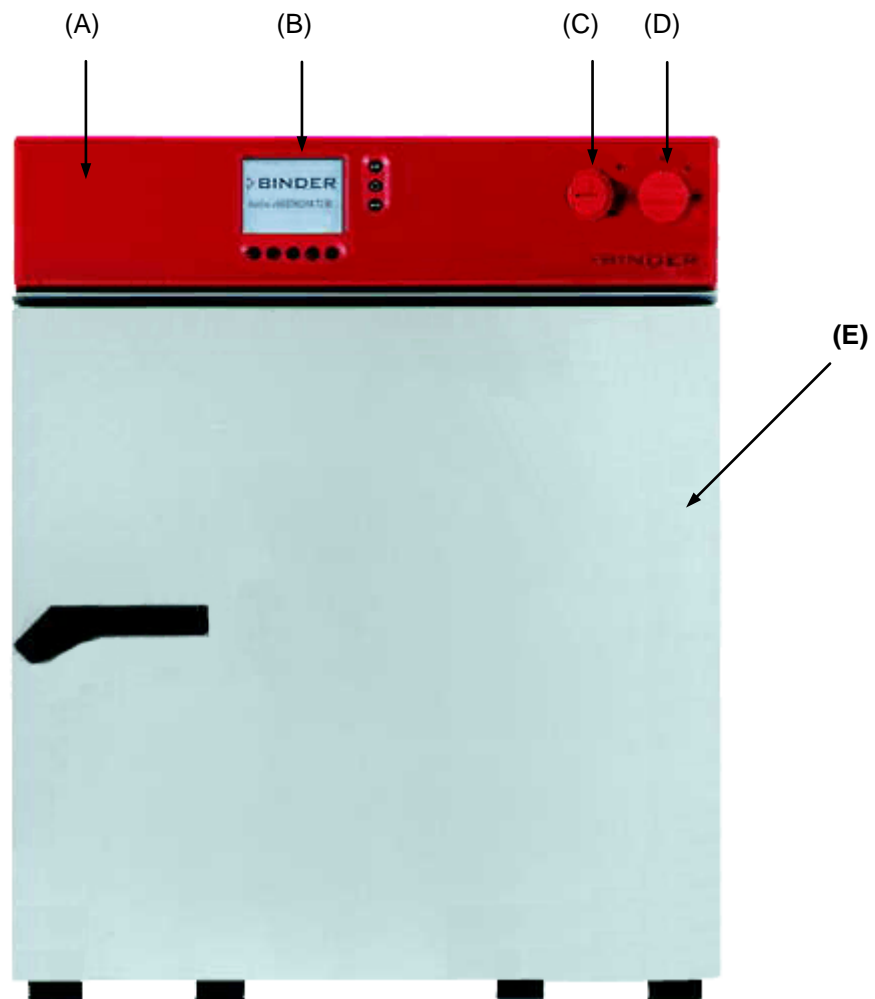

Figure 3: Drying and heating oven M 53

- (A) Instrument panel
- (B) Microprocessor program controller MB1
- (C) Temperature safety device class 2, according to DIN 12880
- (D) Main power switch ON/OFF
- (E) Outer door

2.2 Control panel

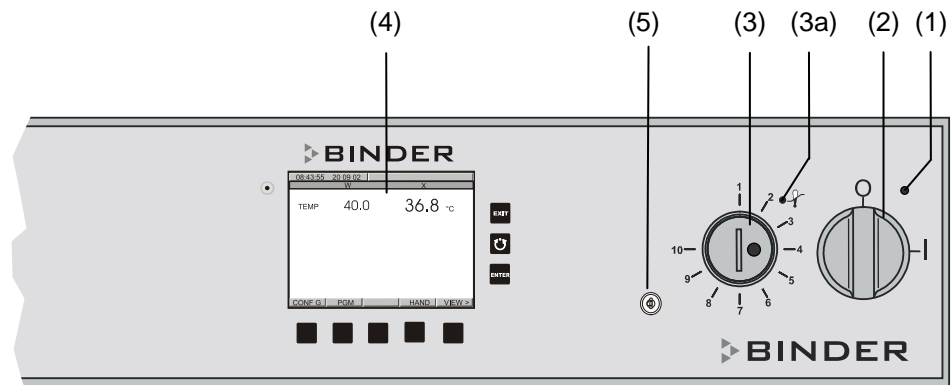

Figure 4: Control panel for M with key switch (option)

- (1) Green pilot lamp: ready for operation
- (2) Main power switch ON/OFF
- (3a) Red pilot lamp of the temperature safety device class 2
- (3) Temperature safety device class 2
- (4) Display program controller MB1
- (5) Key switch (with option keyboard locking, chap. 11.10)

3. Completeness of delivery, transportation, storage, and installation

3.1 Unpacking, and checking equipment and completeness of delivery

After unpacking, please check the chamber and its optional accessories, if any, based on the delivery receipt for completeness and for transportation damage. Inform the carrier immediately if transportation damage has occurred.

The final tests of the manufacturer may cause traces of the shelves on the inner surfaces. This has no impact on the function and performance of the chamber.

Please remove any transportation protection devices and adhesives in/on the chamber and on the doors and take out the operating manuals and accessory equipment.

CAUTION	
 	<p>Sliding or tilting of the chamber. Damage to the chamber. Risk of injury by lifting heavy loads.</p> <ul style="list-style-type: none"> ⊘ Do NOT lift or transport the chamber using either the door or the handle. ⊘ Do NOT lift chambers size 400 and 720 by hand. ➤ Lift chambers size 53, 115 and 240 near the 4 chamber feet from the pallet with the aid of 4 people. ➤ Lift chambers size 400 and 720 using technical devices (fork lifter) from the pallet. Set the fork lifter only from the rear in the middle of the chamber. Make sure to place all the lateral supports of the chamber on the forks.

If you need to return the chamber, please use the original packing and observe the guidelines for safe lifting and transportation (chap. 3.2).

For disposal of the transport packing, see chap. 13.1.





Note on second-hand chambers (Ex-Demo-Units):

Second-hand chambers are chambers that were used for a short time for tests or exhibitions. They are thoroughly tested before resale. BINDER ensures that the chamber is technically sound and will work flawlessly.

Second-hand chambers are marked with a sticker on the chamber door. Please remove the sticker before commissioning the chamber.

3.2 Guidelines for safe lifting and transportation

The front castors of the M 720 can be blocked by brakes. Please move the chambers with castors only when empty and on an even surface, otherwise the castors may be damaged. After operation, please observe the guidelines for temporarily decommissioning the chamber (chap. 13.2).

 CAUTION	
   	<p>Sliding or tilting of the chamber.</p> <p>Damage to the chamber.</p> <p>Risk of injury by lifting heavy loads.</p> <ul style="list-style-type: none"> ➤ Transport the chamber in its original packaging only. ➤ For moving or shipping, secure the chamber with transport straps ⊘ Do NOT lift or transport the chamber using either the door or the handle. ⊘ Do NOT lift chambers size 400 and 720 by hand. ➤ Lift chambers size 53, 115 and 240 near the 4 chamber feet with the aid of 4 people and place it on a transport pallet with wheels. Push the pallet to the desired site and then lift the chamber near the 4 chamber feet from the pallet. ➤ Place chambers size 400 and 720 using technical devices (fork lifter) on the transport pallet. Set the fork lifter only from the rear in the middle of the chamber. Make sure to place all the lateral supports of the chamber on the forks. ➤ Transport chambers size 400 and 720 ONLY with the original transport pallet. Set the fork lifter only to the pallet. Without the pallet the chamber is in imminent danger of overturning.

- Permissible ambient temperature range during transport: -10 °C to +60 °C / 14 °F to 140 °F.

You can order transport packing and pallets for moving or shipping purposes from BINDER Service.

3.3 Storage

Intermediate storage of the chamber is possible in a closed and dry room. Observe the guidelines for temporary decommissioning (chap. 13.2).

- Permissible ambient temperature range during storage: -10 °C to +60 °C / 14 °F to 140 °F.
- Permissible ambient humidity: max. 70 % r.H., non-condensing

When after storage in a cold location you transfer the chamber to its warmer installation site, condensation may form. Before start-up, wait at least one hour until the chamber has attained ambient temperature and is completely dry.

3.4 Location of installation and ambient conditions

Set up the chamber on a flat, even and non-flammable surface, free from vibration, and in a well-ventilated, dry location and align it using a spirit level. The site of installation must be capable of supporting the chamber's weight (see technical data, chap. 15.3). The chambers are designed for setting up inside a building (indoor use).

	CAUTION
	<p>Danger of overheating. Damage to the chamber.</p> <ul style="list-style-type: none"> ⊙ Do NOT set up chambers in non-ventilated recesses. ➤ Ensure sufficient ventilation for dispersal of the heat.

- Permissible ambient temperature range during operation: +18 °C up to +40 °C / 64.4 °F to 104 °F. At elevated ambient temperature values, fluctuations in temperature can occur.

	<p>The ambient temperature should not be substantially higher than the indicated ambient temperature of +25 °C / 77 °F to which the specified technical data relate. In the case of different ambient conditions, deviations from the indicated data are possible.</p>
---	--

- Permissible ambient humidity: 70 % r.H. max., non-condensing.
- Installation height: max. 2000 m / 6562 ft. above sea level.



When placing several chambers of the same size side by side, maintain a minimum distance of 250 mm / 9.84 in between each chamber. Wall distances: rear 100 mm / 3.94 in, sides 160 mm / 6.29 in.



	CAUTION
	<p>Danger by stacking. Damage to the chambers.</p> <ul style="list-style-type: none"> ⊙ Do NOT place the chambers on top of each other.

To completely separate the chamber from the power supply, you must disconnect the power plug. Install the unit in a way that the power plug is easily accessible and can be easily pulled in case of danger.

For the user there is no risk of temporary overvoltages in the sense of EN 61010-1:2010.

Do not install or operate the chambers in potentially explosive areas.

	 DANGER
	<p>Explosion hazard. Danger of death.</p> <ul style="list-style-type: none"> ⊙ Do NOT operate the chamber in potentially explosive areas. ⊙ KEEP explosive dust or air-solvent mixtures AWAY from the vicinity of the chamber.

	 CAUTION
	<p>The exhaust duct will become hot during operation. Danger of burning.</p> <ul style="list-style-type: none"> ⊙ Do NOT touch the exhaust duct during operation.

4. Installation and connections

4.1 Electrical connection

The chambers are supplied ready for connection. They come with a fixed power connection cable of at least 1800 mm / 70.87 in in length.

Model	Power plug	Nominal voltage $\pm 10\%$ at the indicated power frequency	Current type
M 53, M 115, M 240	Shockproof plug	230 V at 50 Hz 230 V at 60 Hz	1N~
M 400, M 720	CEE plug 5 poles	400 V at 50 Hz 400 V at 60 Hz	3N~

- The domestic socket must also provide a protective conductor. Make sure that the connection of the protective conductor of the domestic installations to the chamber's protective conductor meets the latest technology. The protective conductors of the socket and plug must be compatible!
- Prior to connection and start-up, check the power supply voltage. Compare the values to the specified data on the chamber's type plate (chamber front behind the door, bottom left-hand, see chap. 1.4)
- When connecting, please observe the regulations specified by the local electricity supply company as well as the VDE directives (for Germany). We recommend the use of a residual current circuit breaker.
- Pollution degree (acc. to IEC 61010-1): 2
- Over-voltage category (acc. to IEC 61010-1): II

	CAUTION
	<p>Danger of incorrect power supply voltage. Damage to the equipment.</p> <ul style="list-style-type: none"> ➤ Check the power supply voltage before connection and start-up. ➤ Compare the power supply voltage with the data indicated on the type plate.



See also electrical data (chap. 15.3).

	<p>To completely separate the chamber from the power supply, you must disconnect the power plug. Install the chamber in a way that the power plug is easily accessible and can be easily pulled in case of danger.</p>
---	--

4.2 Connection to a suction plant (optional)

When directly connecting a suction plant the spatial temperature exactitude, the heating-up and the recovering times and the maximum temperature will be negatively influenced. So no suction plant should be directly connected to the exhaust duct.

	<p>Active suction from the chamber must only be effected together with extraneous air. Perforate the connecting piece to the suction device or place an exhaust funnel at some distance to the exhaust duct.</p>
---	--

	 CAUTION
	<p>The exhaust duct will become hot during operation. Danger of burning.</p> <ul style="list-style-type: none"> ⊘ Do NOT touch the exhaust duct during operation.

5. Start up

After connecting the electrical supply (chap. 4.1), turn on the chamber via the main power switch (2).

Warming chambers may release odors in the first few days after commissioning. This is not a quality defect. To reduce odors quickly we recommend heating up the chamber to its nominal temperature for one day and in a well-ventilated location.

5.1 Function overview of the MB1 display program controller

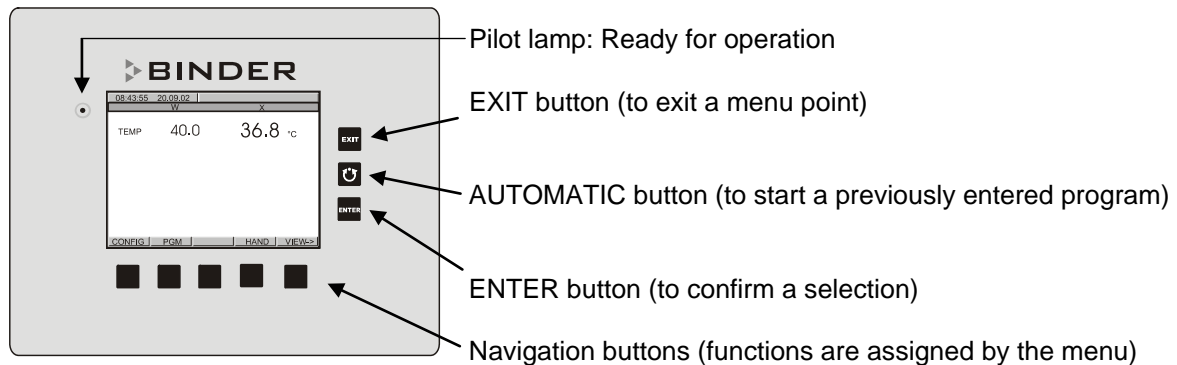

Figure 5: Display program controller MB1

The program controller MB1 controls the temperature inside the chamber (range: 5 °C above ambient temperature up to 300 °C).

You can enter the desired set point values in Manual Mode or Program Mode (chap. 5.2) in the display controller.

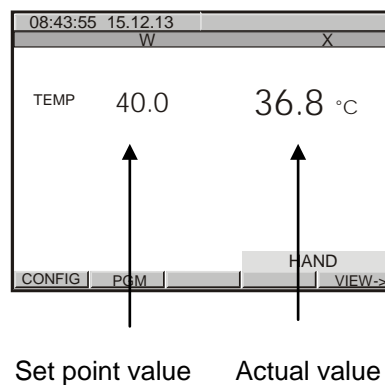

Figure 6: Normal display of the MB1 program controller in Manual mode

5.2 Operating modes

The program controller MB1 operates in 3 modes:

Idle Mode	The controller is not functional, i.e., there is no heating. The fan turns at a 50% rate.
Manual Mode (Fixed value operation) (HAND)	The controller operates as a fixed-point control, i.e., a temperature set-point can be defined, which is then maintained (chap. 8).
Program Mode (AUTO)	An entered temperature program is run (chap. 9).

The program controller MB1 allows programming temperature cycles.

The controller offers 25 program memory positions with 100 program sections each. The total number of program sections of all programs is limited to 500.

Programming can be done directly through the keypad of the controller or graphically through the APT-COM™ 4 Multi Management Software (option, chap. 11.1) specially developed by BINDER.

5.3 Performance after power failures

After the power returns, the chamber continues to function in the original operating mode it was in previously before an actual power failure had occurred. In Manual Mode (HAND), the controller regulates the temperature to the last entered set-points, while in Program Mode (AUTO) it regulates the temperature to its set-point that was reached during the program operation. The power failure is noted in the event list (chap. 6.2) however, no error message is displayed indicating that a power failure has taken place.

5.4 Turning on the chamber

Set the main power switch (2) to position I. The pilot lamp shows the chamber is ready for operation.

	Observe a delay time of approx. 30s between turning Off and On again. Otherwise an initialization problem may occur (display showing e.g. “-1999”).
---	---

Note that the chamber is in stand-by mode when the main power switch is in position I and the controller display is dark. Turn on the chamber by pressing any button. When turned on, the chamber functions in the operating mode entered before turning off. In Manual Mode (HAND), the controller regulates the temperature to the last entered set-point, and in Program Mode (AUTO) it regulates the temperature to the set-points reached during previous program operation.

Structure of toggling between Idle Mode / Manual Mode / Program Mode:

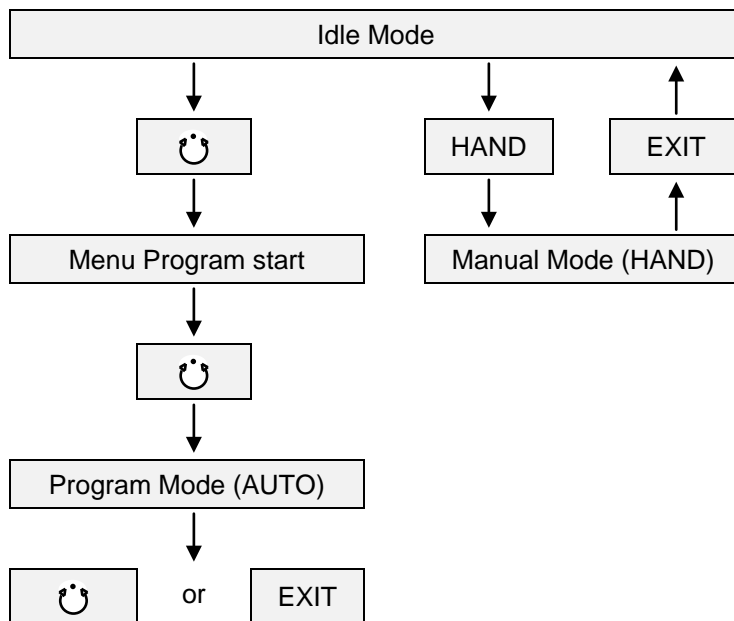

Heating up time

Average heating up time approx. 5 °C/min (the air flap closed and the fan set to maximum speed).

Cooling down time

Average cooling down time approx. 0.2 °C/min to 1.5 °C/min (the air flap open and the fan set to maximum speed).

	If the chamber is fully loaded, the specified heating up and cooling down times may vary according to the load.
---	---

6. Controller MB1 settings

6.1 Selection of the menu language

The display program controller MB1 controls the temperature inside the chamber. The controller communicates by a menu guide using real words in German, English and French.

The selection of the desired menu language is located in the sub-menu "User-Level" of the "User-Settings" menu. Select menu point "Language".

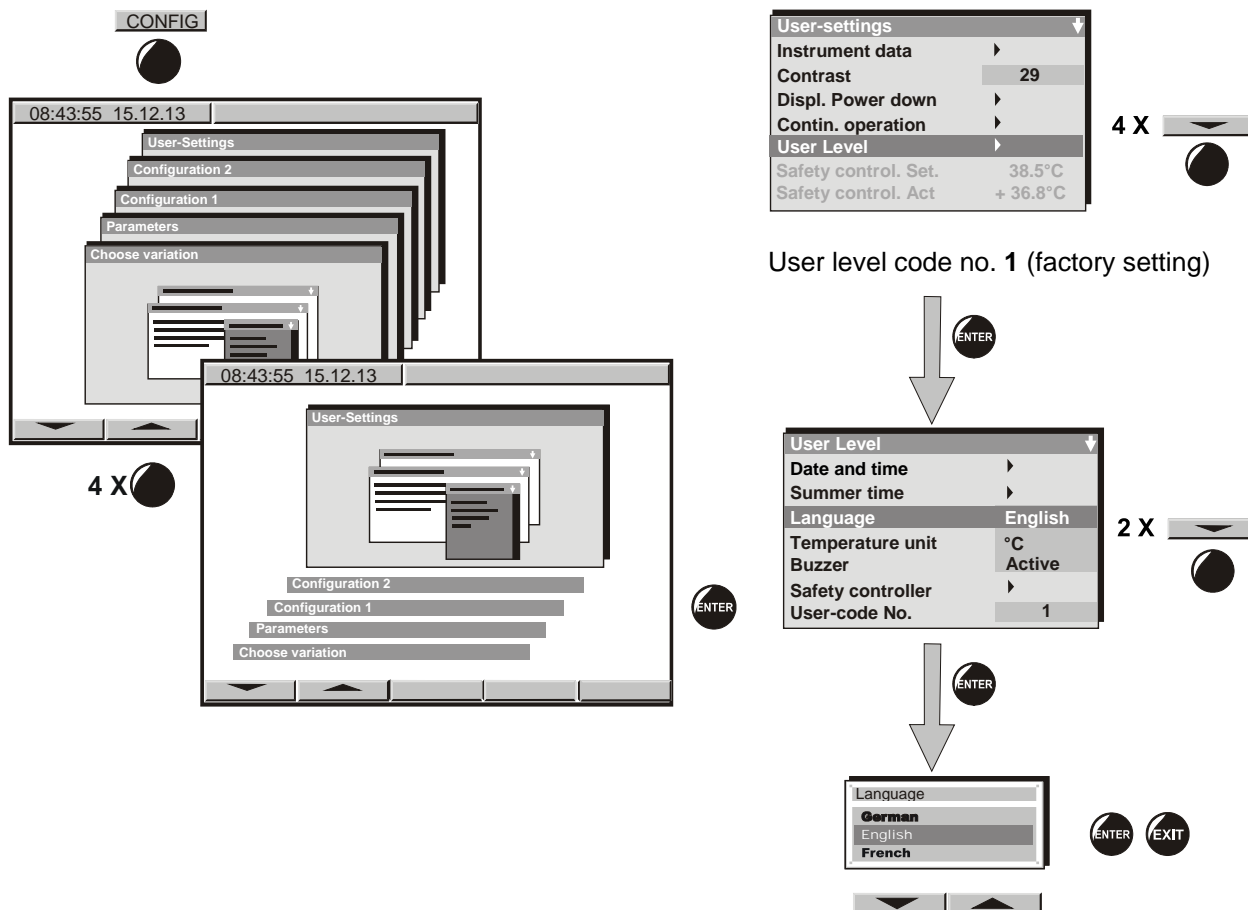

The row of buttons below the display is context-sensitive. The inscription above the buttons on the display defines the button's function.

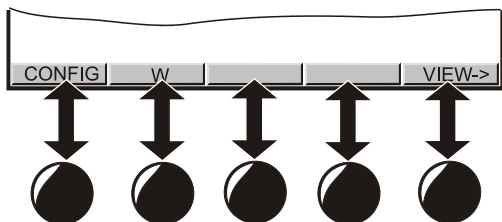

Do NOT change the temperature unit from °C to °F.

6.2 Overview of program controller MB1 displays

The main operation level contains the following different displays:

- **Normal display** (Idle Mode or Manual Mode or Program Mode)
- **Event List**
- **Chart recorder function**
- **Contact page**

Button **VIEW->** allows toggling between the displays.

The NORMAL DISPLAY enables comparison of the current temperature (W) to the set-point value (X) or shows the fan working rate.



BINDER Service contact display.

NORMAL DISPLAY Idle Mode

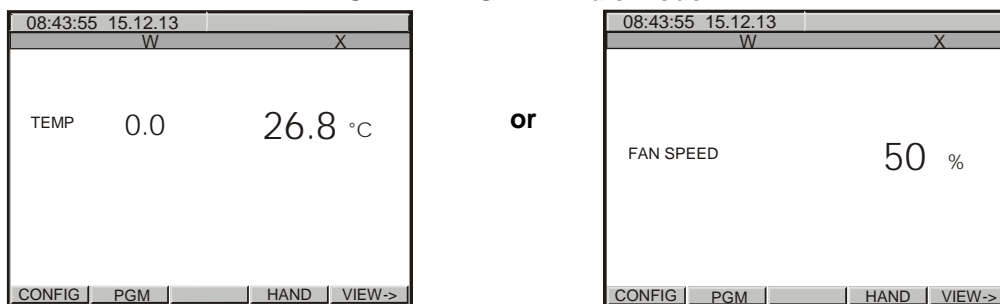

No heating. The actual value (X) approximates ambient temperature. Fan operates at a 50% rate.

NORMAL DISPLAY Manual Mode

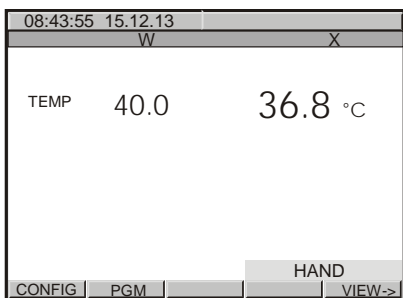

The temperature value is maintained according to the previous entered set-point (W).

NORMAL DISPLAY Program Mode

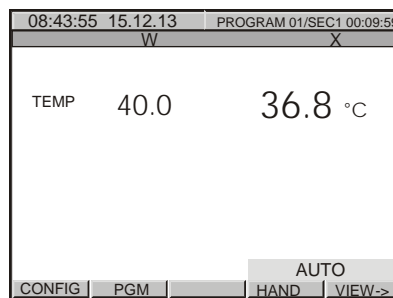

A temperature program entered before via a program table is run.

EVENT LIST

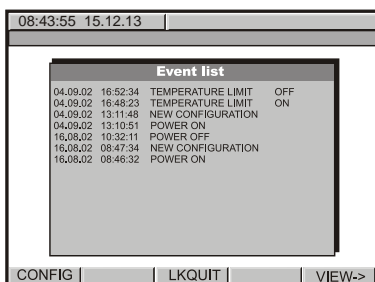

Overview over the last 16 events or error occurrences of the chamber.

CHART RECORDER FUNCTION

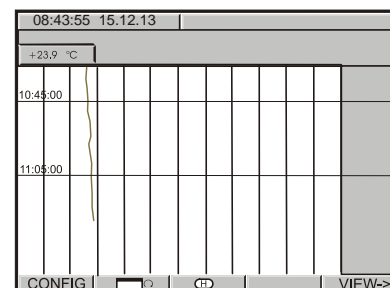

Graphical display of the current temperature values and review of the previous measurements on a historical display. A memory interval of 5s corresponds to a supervision period of 2.5 days.

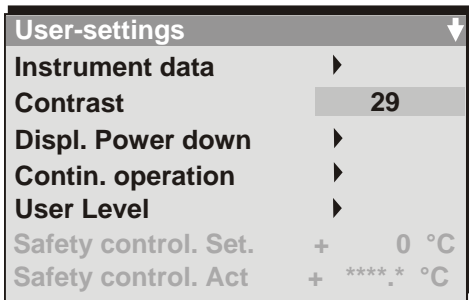

6.3 Menu settings in the “User-settings” menu

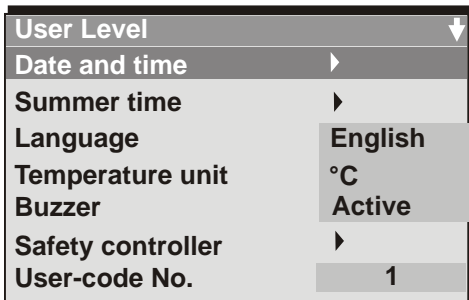

Instrument data	<p>Instrument Name</p> <p>Enter an individual name of the constant climate chamber.</p> <p>Address</p> <p>Enter a controller address (1 to 30) for operation with the APT-COM™ 4 Multi Management Software.</p> <p>All other entries are relevant only for service purposes.</p>
Contrast	(no function)
Displ. power down	<p>Switch off event</p> <p>Do not change the entry “Wait. Period”.</p> <p>Waiting period</p> <p>You can enter a delay time after which the display, following manual activation, will automatically be turned off. This happens when the moment is outside the operation time defined in menu “Contin. operation”.</p>
Contin. operation	Enter an operation time to determine the period of display activity. Outside the defined time, the display is automatically turned off. Pressing down any key will reactivate the display. After the time set in menu “Displ. power down”, the display will turn off again when the actual time is not within the operation time fixed in menu “Cont. operation”.
User Level	Toggle here to the display menu “User Level” (chap. 6.4) by entering a password. Factory default setting for this password is +00001. You can change the password (“user code”) in the menu “User Level”.
Safety control.Set	The safety controller is not used with the actual controller version. The displays are without function.
Safety control.Act	The safety controller is not used with the actual controller version. The displays are without function.

6.4 Menu settings in the “User Level” menu



Date and time	Enter the actual date and time to provide the proper measurement records. Data is displayed in the chart recorder function (chap. 7) of the controller and will remain stored in case of a power failure.	
Summer time	Time is set one hour in advance during the summer time period. Setting the summer time switch: <ul style="list-style-type: none"> • Off: No change to summer time occurs • User timed: Beginning and end of summer time can be set individually • Automatic: The summer time arrangement for central Europe is enabled (summer time from last Sunday of March until last Sunday of October) 	
Language	Select the menu language as German, English, or French (chap. 6.1).	
Temperature unit		Do NOT change the temperature unit from °C to °F.
Buzzer	The buzzer is not used with the actual controller version. The displays are without function.	
Safety controller	The safety controller is not used with the actual controller version. The displays are without function.	
User-Code No.	Change the password (“user code”) needed to access the menu “User level”. Factory default setting +00001.	
		Keep in mind any modification of the user password. There is no access to this menu without the correct password.

7. Graphic representation of the historical measurement (chart recorder function)

The representation of data imitates a chart recorder and allows recalling any set of measured data at any point of time taken from the recorded period.

Normal display of the chart recorder function:

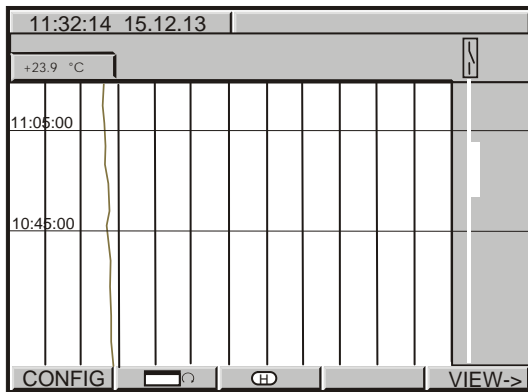

Top left: The actual date and time are displayed.

Below: The current temperature value [°C] is numerically and graphically displayed.

Scaling of temperature: 0 °C to 300 °C.

The open air flap is displayed on the right side as a thick line.

Button  allows toggling between different representations.

Depending on the selected kind of representation, button  might not have been visible until this procedure.

History display with cursor:

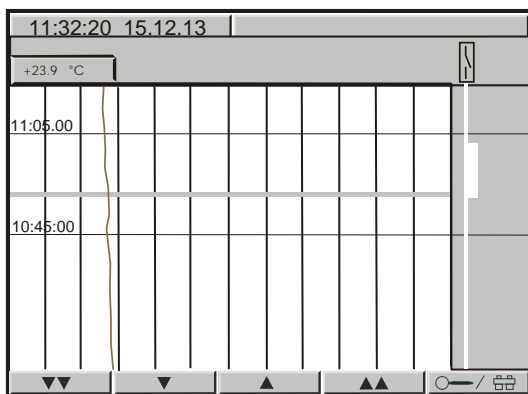

Select button  = History. A pink line appears on the display marking as a cursor the selected moment. You can now recall the recorded data of any defined moment.

Top left: Date and time of the selected cursor position are displayed.

Below: The corresponding temperature value of this instance is numerically and graphically displayed.

Scroll the cursor position using the arrow buttons.

Single arrow buttons: fine-tuning.

Double arrow buttons: page-up and page-down.

Toggle to the zoom display by pressing button  :

History - zoom function:

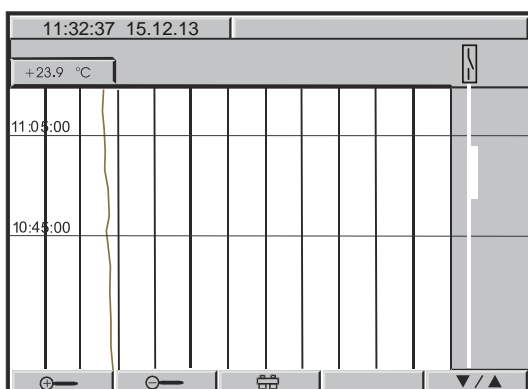

Magnifier buttons  : Zoom and zoom back (i.e., shorten or extend the displayed period).

Toggle back to the former representation display using this button .

You can also directly enter any cursor position as a numerical input.

History representation: Toggling to any defined moment:

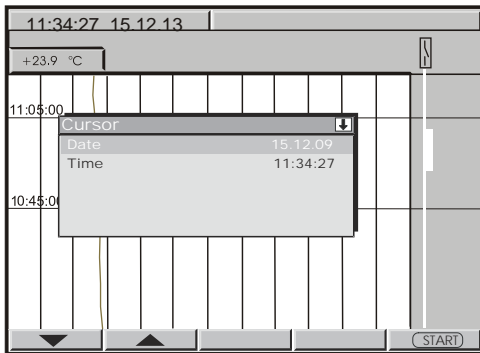

Press button . The window "Cursor position" opens to enter date and time.

Select date or time with the arrow buttons and confirm with ENTER.

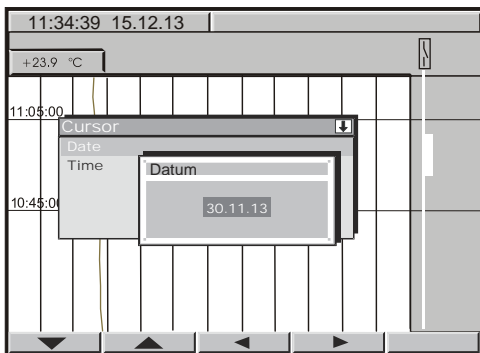

Now you can access any moment that you would like to recall. Enter date and time with the arrow buttons and confirm with ENTER.

Press button .

History display at the selected point of time:

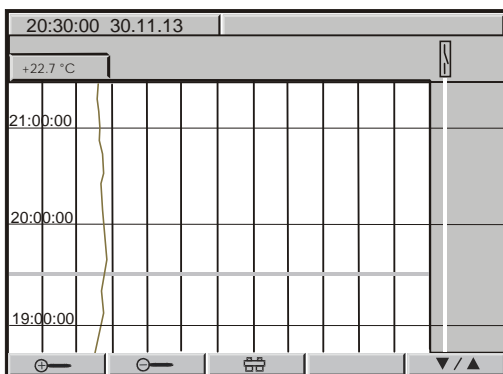

Top left: Date and time of the selected cursor position are displayed.

Below: The corresponding temperature value of this moment is numerically and graphically displayed.

The cursor line marks the corresponding moment.

The available presentation depends on the pre-selected storage rate. This means the higher the storage rate, the more precisely but shorter the data representation will be, see table below:

Storage rate	Storage duration	
	(hours)	(days)
5 sec	60	2.5
10 sec	120	5
1 min	720	30
5 min	3600	150
10 min	7200	300

CAUTION

**Setting the storage rate clears the measured-value memory.
Danger of information loss.**

➤ Change the storage rate **ONLY** if the previously registered data is no longer needed.

8. Manual Mode

In Manual Mode (HAND) you can enter a temperature set-point, the fan speed (0% to 100%), and the switching-state of up to 8 operation lines. Operation line 1 is used to control the air flap position. The other operation lines are non-functional. All settings remain valid in Manual Mode (HAND) until the next manual change, if the chamber had been turned off or in case of toggling to Idle Mode or Program Mode (AUTO).

8.1 Entering the set point values

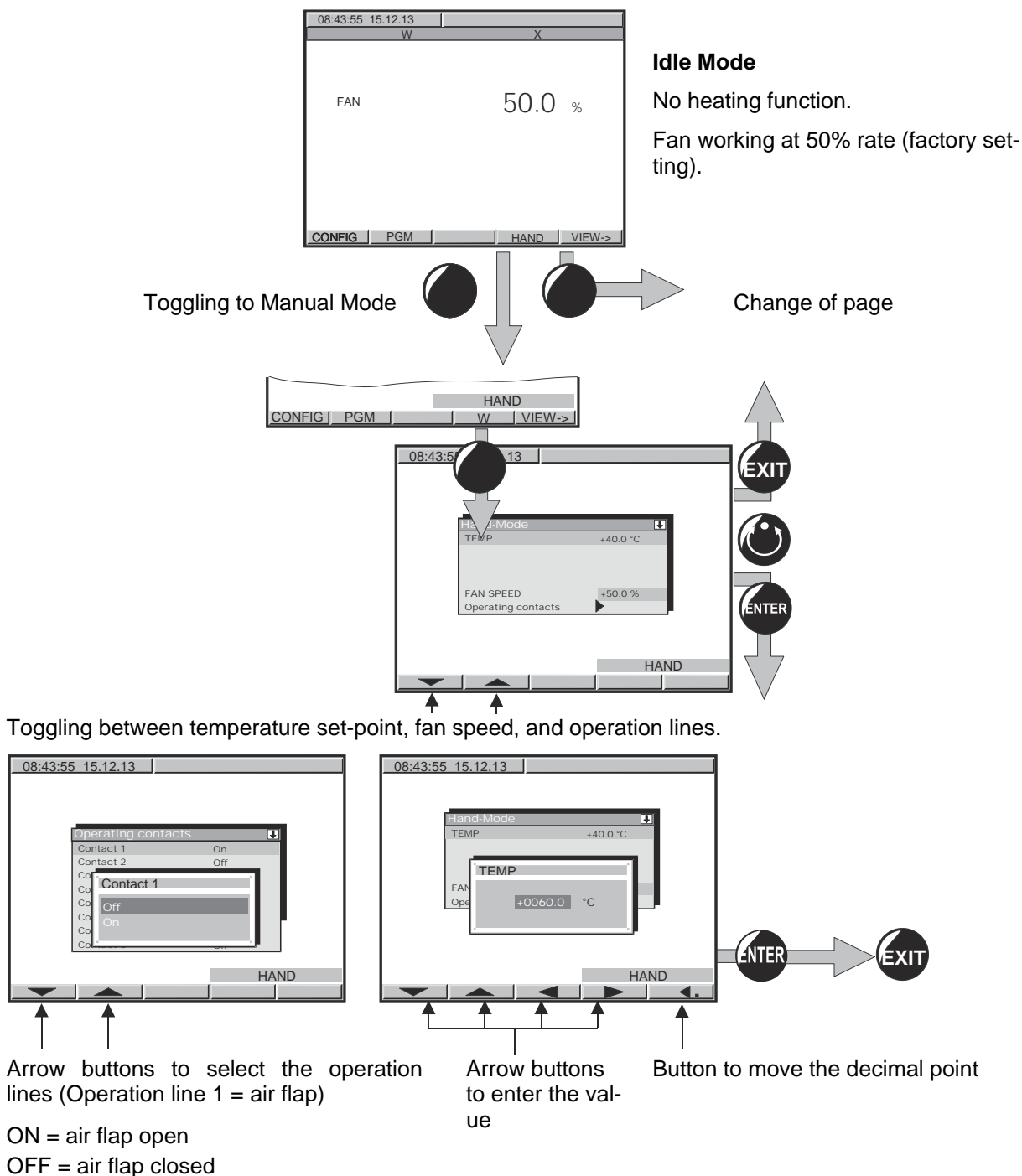

Unlock the keyboard locking (option, chap. 11.10) via the key switch to enter the set-point.

Setting ranges:

Temperature	0 °C up to 300 °C
Fan speed	0 % to 100 % Fan speed can be reduced to standstill of the fan. Do this only if needed, because the spatial distribution of temperature will also be reduced. Technical data refer to 100% fan speed.

	<p>Adapt the temperature safety device class 2 (chap. 10.1) or the temperature safety device class 3.1 (option, chap. 10.2) every time the set-point for temperature is changed.</p> <p>Set the set-point of temperature safety device class 2 or class 3.1 (option) by about 5 °C to 10 °C above the controller temperature set-point.</p>
---	---

If operation line 1 has been set to ON, i.e., the air flap is open, the notification “AIR FLAP OPEN” is displayed on the controller MB1 display next to a flashing blue information symbol.



In Manual Mode, no program can be started. A set-point can be entered for temperature. The actual value equilibrates to this set-point.

When pushing the EXIT button in Manual Mode, the controller changes to Idle Mode. The set-points entered in Manual Mode remain saved.

	<p>When incidentally pressing the EXIT or AUTOMATIC button during Manual Mode operation, the controller will change to Idle Mode and thus will not adjust any longer to the program set-points.</p> <p>We recommend keyboard locking (available via BINDER INDIVIDUAL customized solutions, see chap. 11.10.) during operation.</p>
--	---

8.2 Performance after power failure in Manual Mode

In Manual Mode (HAND), all functions return exactly to the same status the chamber had before power failure. The set-point is immediately resumed, the switching states of the operation lines are conserved. No error message indicating that a power failure has taken place is displayed. However, the power failure will appear in the event list.

9. Program operation

The 1-channel program controller MB1 permits programming temperature cycles. It offers 25 program memory positions with 100 program sections each. The total cumulative number of program sections is limited to 500. It is not possible to link several programs.

For each program section a temperature set-point, the fan speed (0% up to 100%), and the switching-state of up to 8 operation lines can be entered. Operating line 1 is used to control the air flap position. The other operation lines are non-functional.

Programming is possible directly by the keypad of the controller or graphically by the APT-COM™ 4 Multi Management Software (option, chap. 11.1) specially developed by BINDER.

9.1 Menu-based program entry

Displays showing the initial normal display in Idle Mode

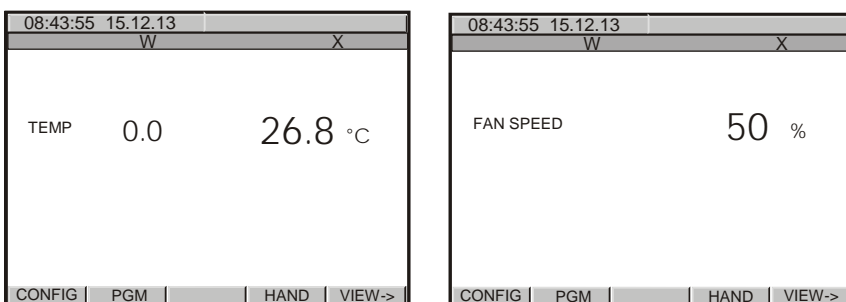

Hit button PGM. The window **program selection** appears

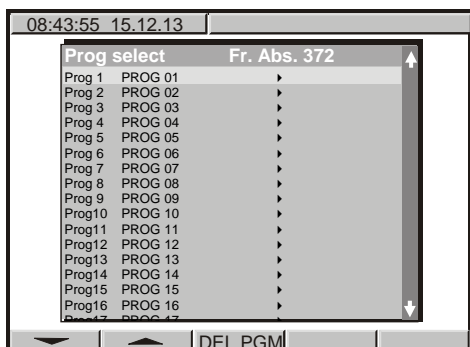

Select a program via the arrow keys and confirm by pressing "ENTER"

The following display serves to select a **subroutine**:

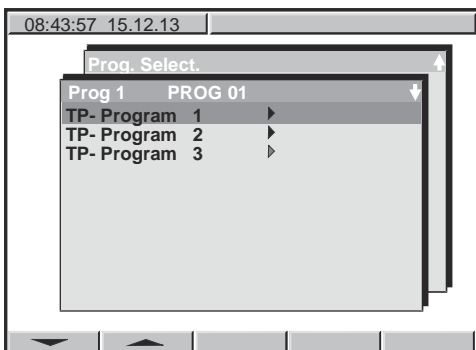

Select the first subroutine "TP-Program 1" (TP-Program 2 und TP-Program 3 are without function) and confirm by pressing "ENTER".

A **program table** will appear, which is initially empty until you enter the temperature values. You can now enter the temperature program.

Temperature at the beginning of the program section

Subprogram TP-Program No. 1

Fan speed in %

Factory setting:
50% in Idle Mode
100 % in Manual Mode and
Program Mode

Duration of program section

Pgm-Editor		Pgm-Name		PROG 03				
Pgm-Nr	?	ZP-Prog-Nr	1	Abschn.	0			
No	W-I	FAN	Time	Sk	No Cy	Tmin	Tmax	Pa

Total number of program sections

Parameter set (preselected)

Tolerance band limits temperature (maximum and minimum temperature)

Operation line 1 (air flap)

Number of start section in case of repeat cycles

Number of duplicates in case of repeat cycles

You can enter **Program sections** into this program table.

Hit the PGM button. An inquiry display appears allowing you to enter or delete individual program sections:



In this view, new program lines can be entered or deleted:

new	New lines are added below in the table
insert	New lines are added above a previously selected line
delete	Individual lines that have been selected previously are deleted

Create as many lines, i.e. program sections, as desired. As a next step, values can be entered into these lines. It is possible to add supplementary lines later or to delete individual lines at any time.

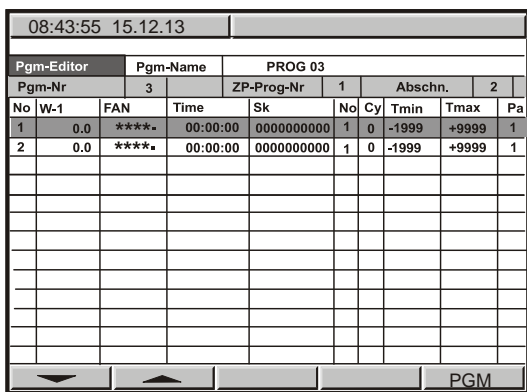

To enter values, select the corresponding line via the arrow keys.

Hit the "ENTER" button. The **program editor** appears.

Enter the individual values of the selected program section.

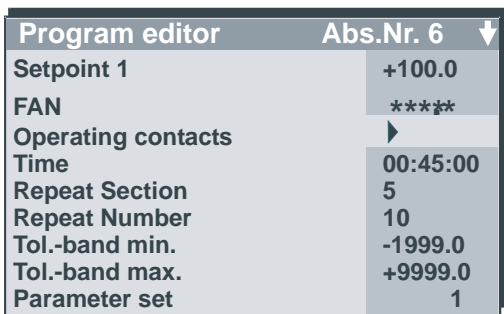

- Temperature value at the start of the program section
- Fan speed in %
- Operating contact (operation line) 1 = air flap open / closed
- Duration of the program section
- No. of start section in case of repeat cycles
- No. of duplicates in case of repeat cycles
- Temperature limits (maximum / minimum temperature). **In case of exceeding: temporary program stop.**
- Pre-selected value (Do NOT change!)

Select the parameters via the arrow keys and confirm by pressing "ENTER"..

Then enter the values via the arrow keys, and confirm the entry by pressing "ENTER"..



Adapt the temperature safety device class 2 (chap. 10.1) or the temperature safety device class 3.1 (option, chap. 10.2) to the highest temperature set-point value of the program actually used. Check the safety device for each temperature program and adapt it if necessary.

Set the set-point of temperature safety device class 2 or class 3.1 (option) by about 5 °C to 10 °C above the controller temperature set-point.

Performance after completing the program:

The controller changes to Idle Mode. The heating is inactive; the chamber approximates ambient temperature. The fan turns at a 50% rate.

9.2 Selecting between set-point ramp and set-point step

Temperature set-points always refer to the start of a program section, i.e., at the beginning of each program section the entered temperature set-point is targeted. During program section operation, the temperature gradually passes to the set-point entered for the next program section.

By appropriate planning of the program section timing, you can enter all kinds of temperature transitions.

- **Gradual temperature changes “set-point ramp”**

The set-point changes its value gradually while proceeding from one program section to the next one during the programmed section length. The actual temperature value (X) follows the continually moving set-point (W) at any time.

- **Program sections with constant temperature**

The initial values of two subsequent program sections are identical; so the temperature remains constant during the whole time of the first program section.

- **Sudden temperature changes “set-point step”**

Steps are temperature changes (ramps) that occur during a very short interval. A section with a different set-point follows two program sections with an identical set-point. If the duration of this transitional program section is very short (minimum entry 1 sec), the temperature change will proceed rapidly within the minimum amount of time.

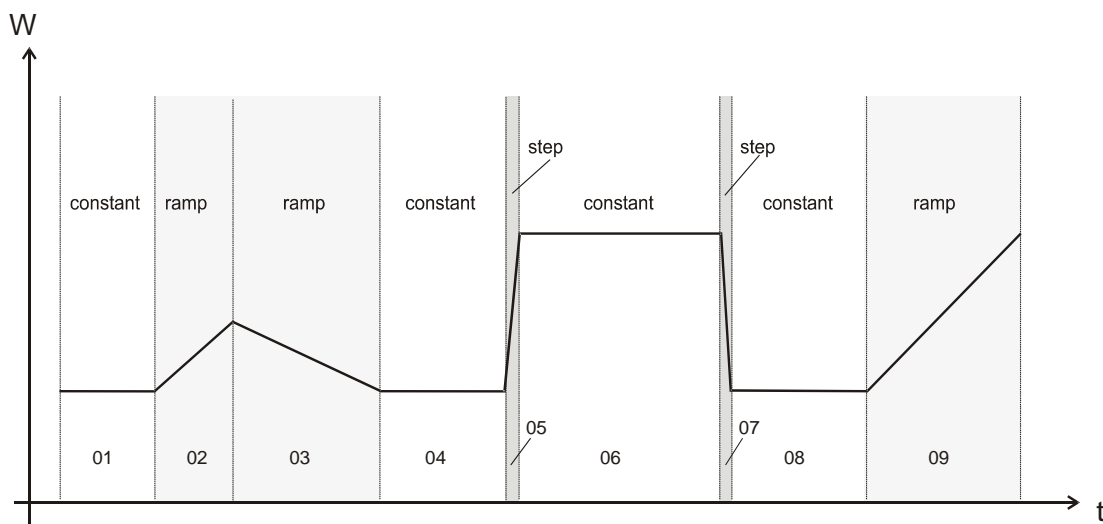

Figure 7: Possible temperature transitions

The following chapter offers examples of programming a set-point ramp and a set-point step.

9.3 Program entry as set-point ramp or as set-point step

In order to avoid incorrect programming, we recommend plotting the temperature profile (chart template in chap. 9.9) and entering the values into a table (templates in chap. 9.10).

The controller provides 8 operation lines that can be activated or de-activated for each program section. Operating contact 1 is used to control the air flap position (ON = Air flap open, OFF = Air flap closed). The other operation lines are non-functional.

The chamber does not provide active refrigeration, but you can program defined cooling down ramps within the range of possible cooling-down times, e.g. in order to avoid tension in the material.

Program entry as set-point step (example)

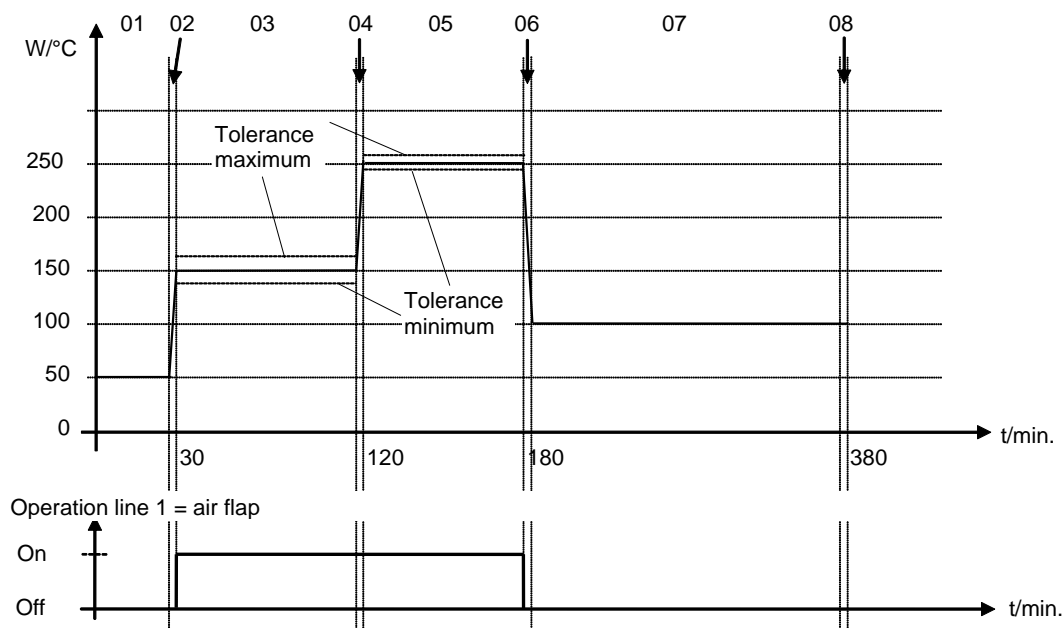

Program table corresponding to the diagram above:

Program section	Set-point temp.	Fan	Section time	Operation line1	Target section	No. of cycles	Min. tolerance	Max. tolerance
01	50	100 %	00:30:00	Off	1	0	-1999	+9999
02	50	100 %	00:00:01	Off	1	0	-1999	+9999
03	150	100 %	01:30:00	On	1	0	-5	+5
04	150	100 %	00:00:01	On	1	0	-1999	+9999
05	250	100 %	01:00:00	On	1	0	-2	+2
06	250	100 %	00:00:01	On	1	0	-1999	+9999
07	100	100 %	03:20:00	Off	1	0	-1999	+9999
08	100	100 %	00:00:01	Off	1	0	-1999	+9999

Now enter the values of the above program table into one of the 25 program places of the controller MB1:

09:17:15		15.12.13																	
Pgm-Editor		Pgm-Name		PROG 03															
Pgm-Nr		3		ZP-Prog-Nr		1		Abschn.		5									
No	W-1	FAN	Time	Sk	No	Cy	Tmin	Tmax	Pa										
1	50.0	****a	00:30:00	0000000000	1	0	-1999	+9999	1										
2	50.0	****a	00:00:01	0000000000	1	0	-1999	+9999	1										
3	150.0	****a	01:30:00	0000000001	1	0	- 5	+ 5	1										
4	150.0	****a	00:00:01	0000000001	1	0	-1999	+9999	1										
5	250.0	****a	01:00:00	0000000001	1	0	- 2	+ 2	1										
6	250.0	****a	00:00:01	0000000001	1	0	-1999	+9999	1										
7	100.0	****a	03:20:00	0000000000	1	0	-1999	+9999	1										
8	100.0	****a	00:00:01	0000000000	1	0	-1999	+9999	1										
										PGM									



For rapid transition phases, do NOT program any tolerance limits in order to allow maximum heating speed.

9.4 Information on programming different temperature transitions

- For the end value of the desired cycle, add an additional section (in the examples section 05 for set-point ramp and section 08 for set-point step) with a section time of at least one second. Otherwise, the program will stop one section too early because the program line is incomplete.
- If the tolerance minimum is set to e.g. -5 and the tolerance maximum to e.g. +5, the program is interrupted when the actual value deviates by 5 °C or more from the set-point value. During this program interruption, the display reads at the right below AUTO HAND instead of AUTO (program operation). You can enter different values for tolerance maximum and minimum for each section. When the temperature is situated within the entered tolerance limits, the program is automatically continued. The indication AUTOHAND disappears.



Programming of tolerances can extend program duration.

Therefore, the duration of the program might be extended due to the programming of tolerances.

The number -1999 for the tolerance minimum means “-∞” and the number 9999 for the tolerance maximum means “+ ∞”. Entry of these numbers will never lead to program interruption.

During the rapid transition phase, do NOT program any tolerance limits in order to allow the maximum heating speed.

- The initial setting ****.* of the fan speed corresponds to the maximal speed of 100 %.



Do reduce the fan speed rate ONLY if it is absolutely necessary for the essay. Usually, the spatial exactitude of the temperature decreases with lesser ventilation. Technical data refers to a 100 % fan speed rate.

- Programming is stored even in case of power failure or after turning off the chamber.
- The controller memory can store a maximum of 25 programs. Each program cannot exceed 100 sections. It is not possible to link programs. The total number of program sections of all programs is limited to a maximum of 500.



If you incidentally press the EXIT or AUTOMATIC button during program operation, the controller will change to Idle Mode and thus will not adjust any more to the program set-points.

We recommend keyboard locking (available via BINDER INDIVIDUAL customized solutions, see chap. 11.10.) during operation.

General note:

The controller MB1 displays more menu entries than those described in this manual. These are password protected because they are relevant for service purposes only and the user must not modify them. Only service authorized by BINDER can access these entries.

9.7 Starting a previously entered program

The program has to be previously entered via a programming table (chap. 9.3).

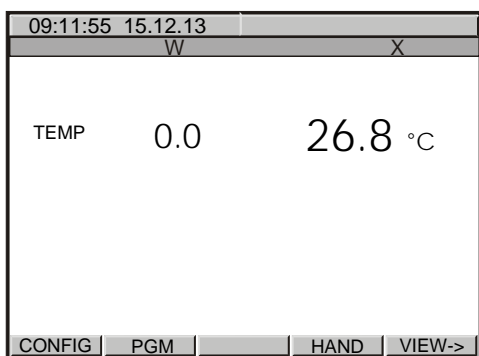

Idle mode

No heating function.
Fan working at 50% rate
(factory setting)

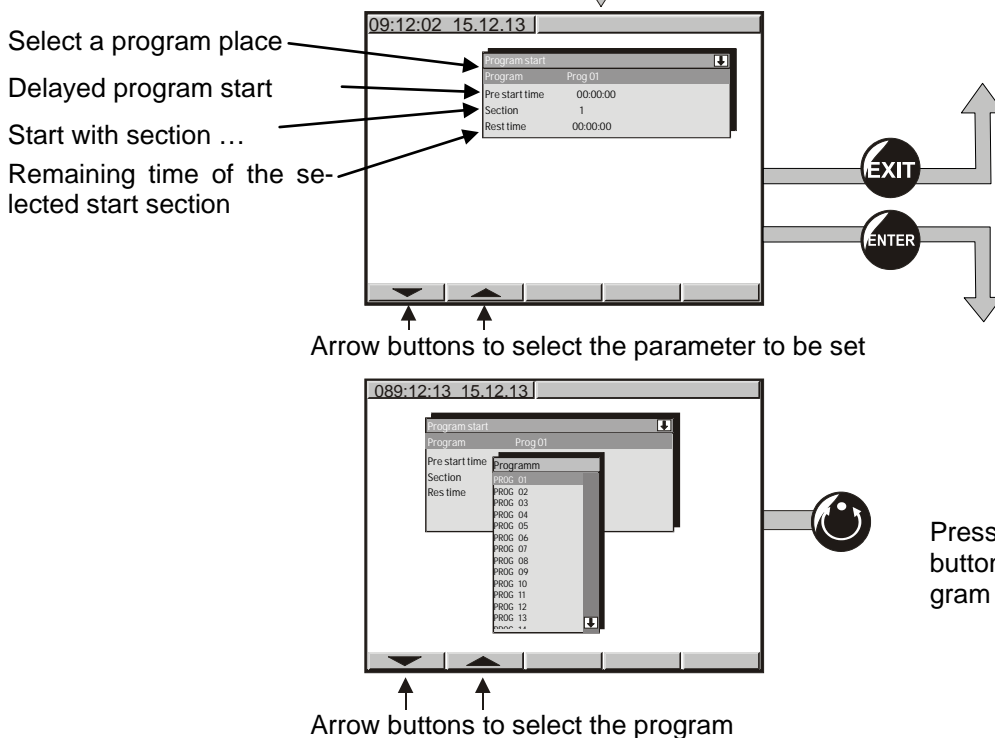

9.8 Deleting a program

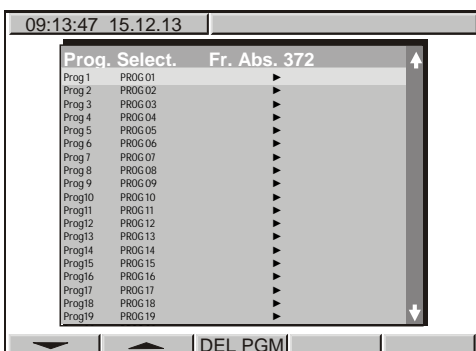

Select a program via the arrow keys

Hit button **DEL PGM** to delete the selected program.

To delete individual program sections (table lines) use the inquiry display for adding or deleting program sections (chap. 9.1).

9.9 Temperature profile template

Programmer:		Program No. (1 to 25):		Date:	
Program title:		Operation line 1 = Position of air flap			
Project:		ON = open, OFF = closed			

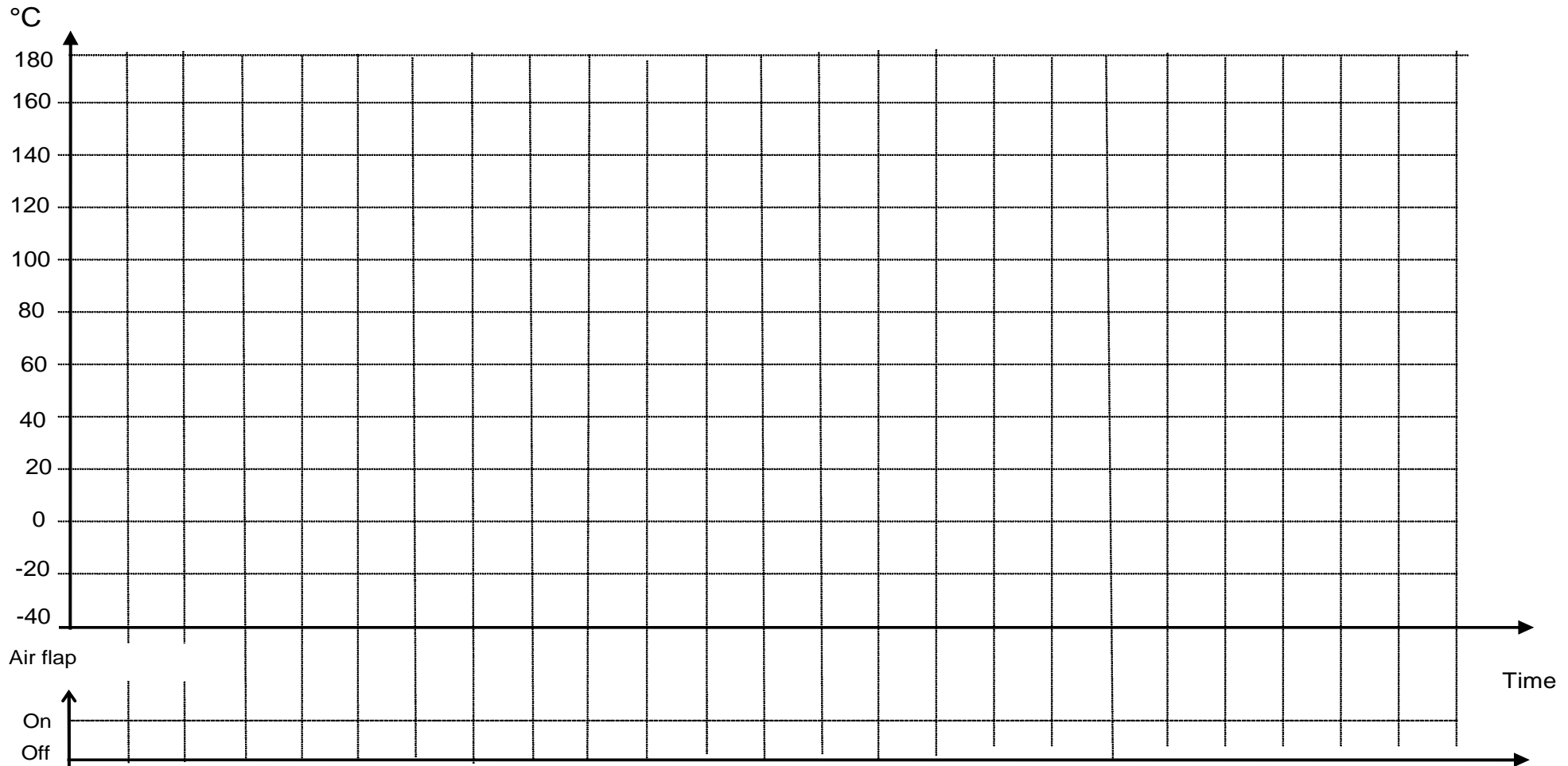

9.10 Program table template

Programmer:		Program No. (1 to 25):		Date:	
Program title:		Operation line 1 = Position of air flap			
Project:		ON = open, OFF = closed			

Section No.	Set-point Temperature	Fan speed [%]	Section time	Operation line 1	Start section for repeat cycles	Number of repeat cycles	Tolerance minimum Temperature	Tolerance maximum Temperature	Parameter set
	W-1	FAN	Time	Sk	No	Cy	Tmin	Tmax	Pa
01									1
02									1
03									1
04									1
05									1
06									1
07									1
08									1
09									1
10									1
11									1
12									1
13									1
14									1
15									1
16									1
17									1
18									1
19									1
20									1

Default setting

10. Temperature safety devices

10.1 Temperature safety device class 2 (DIN 12880)

The temperature safety device class 2 acc. to DIN 12880:2007 protects the chamber, its environment and the charging material from exceeding the maximum permissible temperature.

Please observe the DGUV guidelines 213-850 on safe working in laboratories (formerly BGI/GUV-I 850-0, BGR/GUV-R 120 or ZH 1/119, issued by the employers' liability insurance association) (for Germany).

In the event of a fault in the temperature controller, the safety device (3) **permanently** turns off the chamber. This status is reported visually by the indicator lamp (3a).

Check the operation of the safety device (3) by moving it slowly counter-clockwise until the chamber turns off. The safety device cut-off is reported visually by the indicator lamp (3a).

Then release again the safety device by pressing the reset button (3b), and turn on the chamber as described.

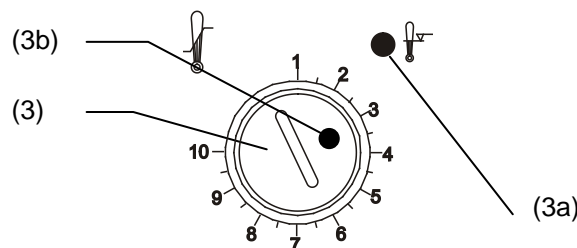

Figure 8: Temperature safety device class 2

Function:

The safety device class 2 is functionally and electrically independent of the temperature control device and turns off the chamber permanently.

If you turn the control knob (3) to its end-stop (position 10), the safety device protects the appliance. If you set it to a temperature a little above the controller's set-point temperature, it protects the charging material.

If the safety device has turned off the chamber, identifiable by the red alarm lamp (3a) lighting up, proceed as follows:

- Disconnect the chamber from the power supply.
- Have an expert examine and rectify the cause of the fault.
- Release the safety device by pressing the reset button (3b).
- Restart the chamber as described in chap. 5.

Setting:

To check the response temperature of the safety device, turn on the chamber and set the desired set-point at the temperature controller.

The sections of the scale from 1 to 10 corresponds to the temperature range from 30 °C / 86 °F up to 320 °C / 608 °F and serves as a setting aid.

- Turn the control knob (3) of the safety device using a coin to its end-stop (position 10) (chamber protection).
- When the set-point is reached, turn back the control knob (3) until its trip point (turn it counter-clockwise)
- The trip point is identifiable by the red alarm lamp (3a) lighting up; the reset button (3b) pops out.
- The optimum setting of the safety device is obtained by turning the control knob clockwise by approx. one graduation mark on the scale.
- Push the reset button (3b) in again.



The chamber is only active with the reset button (3b) pushed in.

When the safety device class 2 responds, the red alarm lamp (3a) illuminates, the reset button (3b) pops out, and the chamber turns off permanently.



Check the setting regularly and adjust it following any changes of the set-point.

Function check:

Check the temperature safety device class 2 at appropriate intervals for its functionality. It is recommended that the authorized operating personnel should perform such a check, e.g., before starting a longer work procedure.

10.2 Temperature safety device class 3.1 (DIN 12880) (available via BINDER INDIVIDUAL customized solutions)

The temperature safety device class 3.1 acc. to DIN 12880:2007 protects the chamber, its environment and the charging material from exceeding the maximum permissible temperature. In the event of a fault, it limits the temperature inside the chamber to the value set on the safety device.

Please observe the DGUV guidelines 213-850 on safe working in laboratories (formerly BGI/GUV-I 850-0, BGR/GUV-R 120 or ZH 1/119, issued by the employers' liability insurance association) (for Germany).

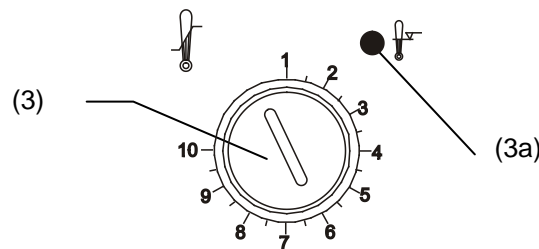

Figure 9: Temperature safety device class 3.1

Function:

The temperature safety device is functionally and electrically independent of the temperature control system and if an error occurs it performs a regulatory function.

If you turn the control knob (3) to its end-stop (position 10), the safety device class 3.1 protects the chamber. If you set it to a temperature a little above the controller's set-point temperature, it protects the charging material. If the safety device class 3.1 has taken over control, identifiable by the red alarm lamp (3a) lighting up, proceed as follows:

- Disconnect the chamber from the power supply.
- Have an expert examine and rectify the cause of the fault.
- Restart the chamber as described in chap. 5.

Setting:

To check the response temperature of the safety device class 3.1, turn on the chamber and set the desired set-point at the temperature controller.

The sections of the scale from 1 to 10 correspond to the temperature range from 63 °C / 145.4 °F up to 350 °C / 662 °F and serve as a setting aid.

- Turn the control knob (3) of the safety device using a coin to its end-stop (position 10) (chamber protection).
- When the set point is reached, turn back the control knob (3) until its trip point (turn it counter-clockwise).
- The trip point is identifiable by the red alarm lamp (3a).
- The optimum setting of the safety device is obtained by turning the control knob clockwise by approx. one scale division, which leads to extinguish the red alarm lamp (3a).

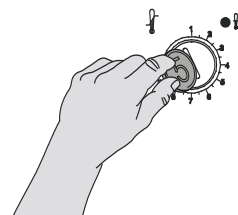

Figure 10: Setting safety device class 3.1



Check the setting regularly and adjust it following any changes of the set-point.

Function check:

Check the temperature safety device class 3.1 at appropriate intervals for its functionality. It is recommended that the authorized operating personnel should perform such a check, e.g., before starting a longer work procedure.

11. Options

11.1 APT-COM™ 4 Multi Management Software (option)

The chamber is regularly equipped with a serial interface RS 422 that can connect the BINDER APT-COM™ 4 Multi Management Software. The actual temperature value is given at adjustable intervals. Programming can be performed graphically via PC. Up to 100 chambers can be cross-linked. For further information, refer to the APT-COM™ 4 operating manual.

Pin allocation of the RS 422 interface:

pin 2:	RxD (+)
pin 3:	TxD (+)
pin 4:	RxD (-)
pin 5:	TxD (-)
pin 7:	Ground

11.2 Ethernet interface

With this option, the chamber is equipped with an Ethernet interface that can connect the BINDER APT-COM™ 4 Multi Management Software. The actual temperature and humidity values are given at adjustable intervals. The MAC Address is indicated below the Ethernet interface. For further information, please refer to the operating manual of the BINDER communication software APT-COM™ 3.

With this option, the additional RS422 interface is only used for service purposes. Do NOT connect it to any network. The interface is labeled accordingly.

11.3 HEPA fresh air filter (option)

With this option, the introduced fresh air is cleaned by means of a high efficiency submicron particulate air filter type HEPA class H 14 (acc. to DIN EN 1822:2009). Replace the filter insert, if necessary, by removing the metal cover of the filter at the left side of the chamber (Art. No. 6014-0003).

11.4 Data logger kit (option)

BINDER Data Logger Kits offer an independent long-term measuring system for temperature. They are equipped with a keyboard and a large LCD display, alarm functions and a real-time function. Measurement data are recorded in the Data Logger and can be read out after the measurement via the RS232 interface of the Data Logger. It offers a programmable measuring interval and permits storing up to 64000 measuring values. Reading out is done with the Data Logger evaluation software. You can give out a combined alarm and status protocol directly to a serial printer.

Data Logger Kit T 350: Temperature range 0 °C / 32 °F up to +350 °C / 662 °F



For detailed information on installation and operation of the BINDER Data Logger, please refer to the mounting instructions Art. No. 7001-0204 and to the original user manual of the manufacturer, supplied with the data logger.

11.5 Additional flexible Pt100-temperature sensor (option)

With this option, an additional flexible temperature sensor Pt 100 allows measuring the chamber temperature or the temperature of the charging material by means of an independent measuring system with Pt 100 entry. The sensor top protective tube of the flexible Pt 100 can be immersed into liquid substances.

Technical data of the Pt 100 sensor:

- Three-wire technique
- Class B (DIN EN 60751)
- Temperature range up to 320 °C
- Stainless steel protective tube 45 mm length material no. 1.4501

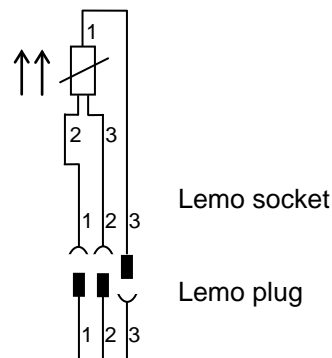

Figure 11: Option temperature sensor Pt 100

11.6 Analog output for temperature (option)

With this option chamber is equipped with an analogue output 4-20 mA for temperature. This output allows transmitting data to external data registration systems or devices.

The connection is realized as a DIN socket on the rear of the chamber as follows:



ANALOG OUTPUT 4-20 mA DC

PIN 1: Temperature –

PIN 2: Temperature +

Temperature range: 0 °C / 32 °F up to 300 °C / 572 °F

A suitable DIN plug is enclosed.

Figure 12: DIN socket for option analog output

11.7 Additional measuring channel for digital object temperature indicator with flexible temperature sensor Pt 100 (option)

The object temperature display enables the determination of the actual temperature of the charging material during the whole process. The object temperature is measured via a flexible Pt100 temperature sensor and can be viewed at the display controller MB1. The sensor top protective tube of the flexible Pt 100 can be immersed into liquid substances.

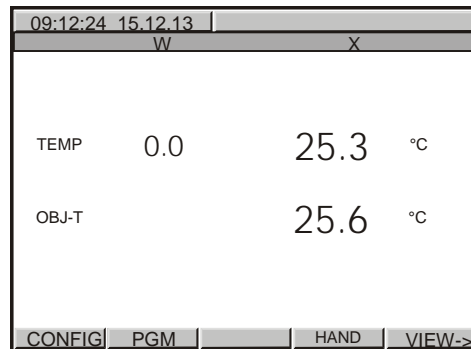

Figure 13: Display controller MB1 with object temperature display

The object temperature data are put out together with the data of the temperature controller to the RS 422 interface as second measuring channel and can be documented by the APT-COM™ 4 Multi Management Software (option, chap. 11.1) developed by BINDER.

Technical data of the Pt 100 sensor:

- Three-wire technique
- Class B (DIN EN 60751)
- Temperature range up to 320 °C / 608 °F
- Stainless steel protective tube 45 mm length, material no. 1.4501

11.8 Mostly gas-tight version (option for M 53 and M 115)

With this option the chamber is additionally sealed, so the loss when introducing gases is decreased. The chamber is not completely gas-tight, so it is impossible to establish overpressure. The sealing diminishes the release of vapors via the housing that may be set free from the charging material when heated. Carrying-off via the regular evacuation duct, e.g. into a waste air installation, is likely to further reduce emissions.

	<p>The chamber is not completely gas-tight. Gases from inside the chamber can escape into the surrounding atmosphere.</p> <p>Observe the occupational exposure limit OEL for the released substance set by the national authorities (formerly maximum permitted workplace concentration). Respect the relevant regulations.</p> <p>Any harmful gas that might escape has to be led out via good room ventilation or a suitable exhaust system. Place the chamber, if necessary, below a gas vent.</p>
---	---

The air flap does not close the exhaust duct completely. The delivered plug serves to avoid emerging of vapors or loss of introduced inert gas, if any, via the exhaust duct. Due to special demands of heat resistance, use the delivered plug only.

	CAUTION
	<p>Use of inappropriate plug.</p> <p>Danger of inflammation.</p> <p>➤ Use only the supplied plug to close the exhaust duct.</p>

For drying purpose, please remove the plug in order to permit dissipation of the generated vapor, which would lead to condensation in the inner chamber.

11.9 Inert gas connection with mostly gas-tight version (option for M 53 and M 115)

With this option the chamber is additionally sealed, so the loss when introducing inert gases is decreased. For details on the mostly gas-tight version please refer to chap. 11.8).

The chamber is equipped with two ports for inert gas (nitrogen or noble gases).

The ports are located **on the top panel in the middle** and **on the right side at the bottom right**. Each of these ports can be used as inlet or outlet, depending on the nature of the inert gas:

- lighter gas (nitrogen, helium): lower port as inlet
- heavy gas (e.g. argon): upper port as inlet

Connection

Observe the legal requirements and relevant standards and regulations for the safe handling of gas cylinders and inert gases.

	<p>General information for safe handling of gas cylinders:</p> <ul style="list-style-type: none"> • Store and use gas cylinders only in well ventilated areas. • Open the gas cylinder valve slowly to avoid pressure surges • Secure gas cylinders during storage and use against falling (chaining). • Transport gas cylinders with a cylinder cart, do not carry, roll, or throw them • Always close the valve even with apparently empty cylinders; screw on the cap when not in use. Return gas cylinders with the valve closed • Do not open gas cylinders by force. Mark them when damaged • Observe relevant regulations for dealing with gas cylinders.
---	---



Connect a flexible gas tube to the gas hose connection adapter (diameter 10mm), which is used for gas inlet, and secure it with hose clamps (hose and hose clamps are not enclosed). There is a constant gas flow after establishing the connection.

	<p>After connecting the gas cylinder, check all gas connections for leaks (e.g. with leak spray or diluted soap solution).</p>
---	--

Use a pressure reducer and make sure to avoid any excessive outlet pressure when connecting the gas hose to the chamber.

	<p>The chamber is not completely gas-tight. Inert gases from inside the chamber can escape into the surrounding atmosphere.</p>
---	---

Inert gases in high concentrations is hazardous to health. They are colorless and almost odorless and therefore practically imperceptible. Inhalation of inert gases can cause drowsiness up to respiratory arrest. When the O₂ content of the air decreases below 18%, there is risk of death from lack of oxygen. Any gas that might escape has to be led out via good room ventilation or a suitable exhaust system.

	 WARNING
	<p>High concentration of inert gas. Risk of death by suffocation.</p> <ul style="list-style-type: none"> ⊙ Do NOT set up chambers in non-ventilated recesses. ➤ Ensure technical ventilation measures. ➤ Respect the relevant regulations for handling these gases.

	<p>Inert gases, which are heavier than air, may accumulate in low-lying areas of the installation site.</p>
---	---

The mostly gas-tight version reduces the loss of gas.

Setting (example values):

If you want to flush the chamber with an air exchange rate of 1 per hour, set the flow rate on the pressure reducer according to the interior volume.

M 53 with 53 l internal volume: The flow rate corresponding to 53 l / h is 0.9 l / min.

M 115 with 115 l internal volume: The flow rate corresponding to 115 l / h is 1.9 l / min.

The air flap does not close the exhaust duct completely. The delivered plug serves to avoid loss of introduced inert gas via the exhaust duct. Due to special demands of heat resistance, use the delivered plug only.

	CAUTION
	<p>Use of inappropriate plug. Danger of inflammation.</p> <ul style="list-style-type: none"> ➤ Use only the supplied plug to close the exhaust duct.

For drying purpose, please remove the plug in order to permit dissipation of the generated vapor, which would lead to condensation in the inner chamber.

11.10 Keyboard locking (option)

The keyboard of the MB1 controller can be locked and unlocked via the key switch (option). In the locked position, no entries to the controller are possible.

- Locked keyboard: Switch in vertical position
- Unlocked keyboard: Switch in position to the right

You can remove the key only when the keyboard is locked.

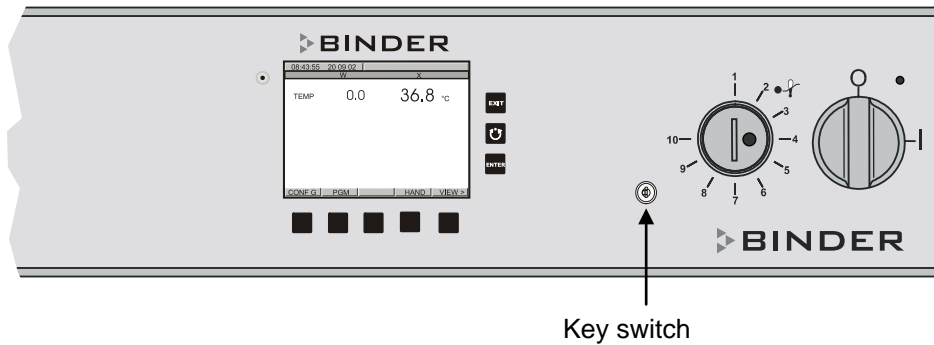

Figure 14: Keyboard locking (option)

If the keyboard is locked, the notification “KEY LOCK” is displayed on the controller MB1 display next to a flashing blue information symbol.



12. Maintenance, cleaning, and service

12.1 Maintenance intervals, service

	DANGER
	<p>Electrical hazard. Danger of death.</p> <ul style="list-style-type: none"> ⊗ The chamber must NOT become wet during operation or maintenance work. ⊗ Do NOT remove the rear panel of the chamber. ➤ Before conducting maintenance work, turn off the chamber at the main power switch and disconnect the power plug. ➤ Ensure all maintenance work is conducted by licensed electricians or experts authorized by BINDER.

Ensure regular maintenance work is performed at least once a year.

	The warranty becomes void if maintenance work is conducted by non-authorized personnel.
--	---

	Replace the door gasket only when cold. Otherwise, the door gasket may become damaged.
--	--



We recommend taking out a maintenance agreement. Please consult BINDER Service.

BINDER telephone hotline:	+49 (0) 7462 2005 555
BINDER fax hotline:	+49 (0) 7462 2005 93555
BINDER e-mail hotline:	service@binder-world.com
BINDER service hotline USA:	+1 866 885 9794 or +1 631 224 4340 x3 (toll-free in the USA)
BINDER service hotline Asia Pacific:	+852 390 705 04 or +852 390 705 03
BINDER service hotline Russia and CIS:	+7 495 988 15 16
BINDER Internet website:	http://www.binder-world.com
BINDER address:	BINDER GmbH, post office box 102, 78502 Tuttlingen, Germany

International customers, please contact your local BINDER distributor.

12.2 Cleaning and decontamination

Clean the chamber after each use to avoid potential corrosion damage by ingredients of the test material.

	 DANGER
	<p>Electrical hazard.</p> <p>Danger of death.</p> <ul style="list-style-type: none"> ⊘ Do NOT spill water or cleaning agents over the inner and outer surfaces. ➤ Before cleaning, turn off the chamber at the main power switch and disconnect the power plug. ➤ Completely dry the appliance before turning it on again.

12.2.1 Cleaning

Disconnect the chamber from the power supply before cleaning. Disconnect the power plug.

	The interior of the chamber must be kept clean. Thoroughly remove any residues of test material.
---	--

Wipe the surfaces with a moistened towel. In addition, you can use the following cleaning agents:

Exterior surfaces inner chamber racks door gaskets	Standard commercial cleaning detergents free from acid or halides. Alcohol based solutions. We recommend using the neutral cleaning agent Art. No. 1002-0016.
Instrument panel	Standard commercial cleaning detergents free from acid or halides. We recommend using the neutral cleaning agent Art. No. 1002-0016.
Zinc coated hinge parts rear chamber wall	Standard commercial cleaning detergents free from acid or halides. Do NOT use a neutral cleaning agent on zinc coated surfaces.

Do not use cleaning agents that may cause a hazard due to reaction with components of the device or the charging material. If there is doubt regarding the suitability of cleaning products, please contact BINDER service.

	<p>We recommend using the neutral cleaning agent Art. No. Art. Nr. 1002-0016 for a thorough cleaning.</p> <p>Any corrosive damage that may arise following use of other cleaning agents is excluded from liability by BINDER GmbH.</p> <p>Any corrosive damage caused by a lack of cleaning, is excluded from liability by BINDER GmbH.</p>
---	---

	<p style="text-align: center;">CAUTION</p> <p>Danger of corrosion.</p> <p>Damage to the chamber.</p> <ul style="list-style-type: none"> ⊘ Do NOT use acidic or chlorine cleaning detergents. ⊘ Do NOT use a neutral cleaning agent on other kind of surfaces e.g., the zinc coated hinge parts or the rear chamber wall.
---	---

	<p>For surface protection, perform cleaning as quickly as possible.</p> <p>After cleaning completely remove cleaning agents from the surfaces with a moistened towel. Let the chamber dry.</p>
---	--



	<p>Soapsuds may contain chlorides and must therefore NOT be used for cleaning.</p>
--	--

	<p>With every cleaning method, always use adequate personal safety controls.</p>
---	--

Following cleaning, leave the chamber door open or remove the access port plugs (option).

	<p>The neutral cleaning agent may cause health problems in contact with skin and if ingested. Follow the operating instructions and safety hints labeled on the bottle of the neutral cleaning agent.</p>
---	---

Recommended precautions: To protect the eyes use sealed protective goggles. Suitable protective gloves with full contact: butyl or nitrile rubber, penetration time >480 minutes.

	<p style="text-align: center;"> CAUTION</p> <p>Contact with skin, ingestion.</p> <p>Skin and eye damage due to chemical burns.</p> <ul style="list-style-type: none"> ⊘ Do not ingest. Keep away from food and beverages. ⊘ Do NOT empty into drains. ➤ Wear protective gloves and goggles. ➤ Avoid skin contact.
---	---

12.2.2 Decontamination

The operator must ensure that proper decontamination is performed in case a contamination of the chamber by hazardous substances has occurred.

Disconnect the chamber from the power supply prior to decontamination. Pull the power plug.

Do not use decontamination agents that may cause a hazard due to reaction with components of the device or the charging material. If there is doubt regarding the suitability of cleaning products, please contact BINDER service.

You can use the following disinfectants:

Inner chamber	Standard commercial surface disinfectants free from acid or halides. Alcohol based solutions. We recommend using the disinfectant spray Art. No. 1002-0022.
---------------	---

	For chemical disinfection, we recommend using the disinfectant spray Art. No. 1002-0022. Any corrosive damage that may arise following use of other disinfectants is excluded from liability by BINDER GmbH.
---	---



	With every decontamination method, always use adequate personal safety controls.
---	--

In case of impurity of the interior with biological or chemical hazardous material, there are 3 possible procedures depending on the type of contamination and of the charging material.

- (1) The chambers can be hot air sterilized at 190 °C for at least 30 minutes. All inflammable goods must be removed from the interior before.
- (2) Spray the inner chamber with an appropriate disinfectant.
Before start-up, the chamber must be absolute dry and ventilated, because explosive gases might form during the decontamination process.
- (3) If necessary, have strongly contaminated inner chamber parts removed by an engineer for cleaning, or have them exchanged. Sterilize the inner chamber parts in a sterilizer or autoclave.

	In case of eye contact, the disinfectant spray may cause eye damage due to chemical burns. Follow the operating instructions and safety hints labeled on the bottle of the disinfectant spray.
---	--

Recommended precautions: To protect the eyes use sealed protective goggles.

	<div style="background-color: yellow; padding: 5px; text-align: center;">  CAUTION </div> <p>Eye contact. Eye damage due to chemical burns.</p> <ul style="list-style-type: none"> ⊘ Do NOT empty into drains. ➤ Wear protective goggles.
---	---



	After using the disinfectant spray, allow the chamber to dry thoroughly, and aerate it sufficiently.
---	--

13.2 Decommissioning

Turn off the main power switch (2) and disconnect the chamber from the power supply (pull the power plug).

	Having turned off the chamber by the main power switch (2), the stored parameters remain saved.
---	---

- With option inert gas connection (chap. 11.9): Close the inert gas supply and remove the gas connection.

	 WARNING
	<p>High concentration of inert gas. Risk of death by suffocation.</p> <ul style="list-style-type: none"> ➤ Respect the relevant regulations for handling these gases. ➤ When decommissioning the chamber, turn off the inert gas supply.

- Temporal decommissioning: See indications for appropriate storage, chap. 3.3.
- Final decommissioning: Dispose of the chamber as described in chap. 13.3 to 13.5.

13.3 Disposal of the chamber in the Federal Republic of Germany

According to Annex I of Directive 2012/19/EU of the European Parliament and of the Council on waste electrical and electronic equipment (WEEE), BINDER devices are classified as “monitoring and control instruments” (category 9) only intended for professional use“. They must not be disposed of at public collecting points.

The chambers bear the symbol for the marking of electrical and electronic equipment manufactured / placed on the market in the EU after 13 August 2005 and be disposed of in separate collection according to Directive 2012/19/EU on waste electrical and electronic equipment (WEEE) and German national law for electrical and electronic equipment (Elektro- und Elektronikgerätegesetz, ElektroG). WEEE marking: crossed-out wheeled bin with solid bar under. A significant part of the materials must be recycled in order to protect the environment.

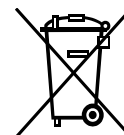



At the end of the device's service life, have the chamber disposed of according to the German national law for electrical and electronic equipment (Elektro- und Elektronikgerätegesetz, ElektroG from 20 October 2015, BGBl. I p. 1739) or contact BINDER service who will organize taking back and disposal of the chamber according to the German national law for electrical and electronic equipment (Elektro- und Elektronikgerätegesetz, ElektroG from 20 October 2015, BGBl. I p. 1739).

	CAUTION
	<p>Violation against existing law.</p> <ul style="list-style-type: none"> ⊘ Do NOT dispose of BINDER devices at public collecting points. ➤ Have the device disposed of professionally at a recycling company which is certified according to the German national law for electrical and electronic equipment (Elektro- und Elektronikgerätegesetz, ElektroG from 20 October 2015, BGBl. I p. 1739). <li style="text-align: center;"><i>or</i> ➤ Instruct BINDER Service to dispose of the device. The general terms of payment and delivery of BINDER GmbH apply, which were valid at the time of purchasing the chamber.

Certified companies disassemble waste (used) BINDER equipment in primary substances for recycling according to Directive 2012/19/EU. The devices must be free from toxic, infectious or radioactive substances in order to eliminate any health hazards to the employees of the recycling companies.

	<p>Prior to handing the chamber over to a recycling company, it is the user's responsibility that it is free from toxic, infectious or radioactive substances.</p> <ul style="list-style-type: none"> • Prior to disposal, clean all introduced or residual toxic substances from the chamber. • Prior to disposal, disinfect the chamber from all sources of infection. Be aware that sources of infection may also be located outside the inner chamber. • If you cannot safely remove all toxic substances and sources of infection from the chamber, dispose of it as special waste according to national law. • Fill out the contamination clearance certificate (chap. 16) and enclose it with the chamber.
---	---

	<div style="background-color: orange; text-align: center; padding: 5px;"> WARNING</div> <p>Contamination of the chamber with toxic, infectious or radioactive substances.</p> <p>Danger of intoxication.</p> <p>Danger of infection.</p> <ul style="list-style-type: none"> ⊘ NEVER take a chamber contaminated with toxic substances or sources of infection for recycling according to Directive 2012/19/EU. ➤ Prior to disposal, remove all toxic substances and sources of infection from the chamber. ➤ A chamber from which all toxic substances or sources of infection cannot be safely removed must be considered as "special" waste according to national law. Dispose of it accordingly.
---	---

13.4 Disposal of the chamber in the member states of the EU except for the Federal Republic of Germany

According to Annex I of Directive 2012/19/EU of the European Parliament and of the Council on waste electrical and electronic equipment (WEEE), BINDER devices are classified as "monitoring and control instruments" (category 9) only intended for professional use". They must not be disposed of at public collecting points.

The chambers bear the symbol for the marking of electrical and electronic equipment manufactured / placed on the market in the EC after 13 August 2005 and be disposed of in separate collection according to the Directive 2012/19/EU on waste electrical and electronic equipment (WEEE). WEEE marking: crossed-out wheeled bin with solid bar under.

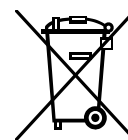





At the end of the device's service life, notify the distributor who sold you the device, who will take back and dispose of the chamber according to the Directive 2012/19/EU on waste electrical and electronic equipment (WEEE).

	<div style="background-color: yellow; text-align: center; padding: 5px;">CAUTION</div> <p>Violation against existing law.</p> <ul style="list-style-type: none"> ⊘ Do NOT dispose of BINDER devices at public collecting points. ➤ Have the device disposed of professionally at a recycling company that is certified according to conversion of the Directive 2012/19/EU into national law. <li style="text-align: center;"><i>or</i> ➤ Instruct the distributor who sold you the device to dispose of it. The agreements apply that were agreed with the distributor when purchasing the chamber (e.g. his general terms of payment and delivery). ➤ If your distributor is not able to take back and dispose of the chamber, please contact BINDER service.
---	--

Certified companies disassemble waste (used) BINDER equipment in primary substances for recycling according to Directive 2012/19/EU. The devices must be free from toxic, infectious or radioactive substances in order to eliminate any health hazards to the employees of the recycling companies.

	<p>Prior to handing the chamber over to a recycling company, it is the user's responsibility that it is free from toxic, infectious or radioactive substances.</p> <ul style="list-style-type: none"> • Prior to disposal clean the chamber from all introduced or sticking toxic substances. • Prior to disposal disinfect the chamber from all sources of infection. Be aware that sources of infection might be located as well outside the inner chamber. • If you cannot safely free the chamber from toxic substances and sources of infection, dispose of it as special waste according to national law. • Fill out the contamination clearance certificate (chap. 16) and enclose it with the chamber.
---	--

	<table border="1"> <tr> <th colspan="2" style="background-color: #FFA500; text-align: center;">  WARNING </th> </tr> <tr> <td colspan="2"> <p>Contamination of the chamber with toxic, infectious or radioactive substances.</p> <p>Danger of intoxication.</p> <p>Danger of infection.</p> <p>Ø NEVER take a chamber contaminated with toxic substances or sources of infection for recycling according to Directive 2012/19/EU.</p> <ul style="list-style-type: none"> ➤ Prior to disposal, remove all toxic substances and sources of infection from the chamber. ➤ A chamber from which all toxic substances or sources of infection cannot be safely removed must be considered as "special" waste according to national law. Dispose of it accordingly. </td> </tr> </table>	 WARNING		<p>Contamination of the chamber with toxic, infectious or radioactive substances.</p> <p>Danger of intoxication.</p> <p>Danger of infection.</p> <p>Ø NEVER take a chamber contaminated with toxic substances or sources of infection for recycling according to Directive 2012/19/EU.</p> <ul style="list-style-type: none"> ➤ Prior to disposal, remove all toxic substances and sources of infection from the chamber. ➤ A chamber from which all toxic substances or sources of infection cannot be safely removed must be considered as "special" waste according to national law. Dispose of it accordingly. 	
 WARNING					
<p>Contamination of the chamber with toxic, infectious or radioactive substances.</p> <p>Danger of intoxication.</p> <p>Danger of infection.</p> <p>Ø NEVER take a chamber contaminated with toxic substances or sources of infection for recycling according to Directive 2012/19/EU.</p> <ul style="list-style-type: none"> ➤ Prior to disposal, remove all toxic substances and sources of infection from the chamber. ➤ A chamber from which all toxic substances or sources of infection cannot be safely removed must be considered as "special" waste according to national law. Dispose of it accordingly. 					

13.5 Disposal of the chamber in non-member states of the EU

	<table border="1"> <tr> <th colspan="2" style="background-color: #FFFF00; text-align: center;"> CAUTION </th> </tr> <tr> <td colspan="2"> <p>Alteration of the environment.</p> <ul style="list-style-type: none"> ➤ For final decommissioning and disposal of the chamber, please contact BINDER service. ➤ Follow the statutory regulations for appropriate, environmentally friendly disposal. </td> </tr> </table>	CAUTION		<p>Alteration of the environment.</p> <ul style="list-style-type: none"> ➤ For final decommissioning and disposal of the chamber, please contact BINDER service. ➤ Follow the statutory regulations for appropriate, environmentally friendly disposal. 	
CAUTION					
<p>Alteration of the environment.</p> <ul style="list-style-type: none"> ➤ For final decommissioning and disposal of the chamber, please contact BINDER service. ➤ Follow the statutory regulations for appropriate, environmentally friendly disposal. 					

The main board of the chamber includes a lithium cell. Please dispose of it according to national regulations.

14. Troubleshooting

Fault description	Possible cause	Required measures
Heating		
Chamber heating permanently, set-point not maintained.	Controller defective.	Contact BINDER service.
	Pt 100 sensor defective.	
	Semiconductor relay defective.	
	Controller not adjusted.	Calibrate and adjust controller.
Chamber doesn't heat up.	Heating element defective.	Contact BINDER service.
	Semiconductor relay defective	
Chamber doesn't heat up when turned on. Safety device class 2 responds.	Limit temperature reached. Safety device class 2 (chap. 10.1) set too low.	Let the chamber cool down and hit RESET button (3b). If appropriate, select suitable limit value.
	Safety controller (chap. 10.1) defective.	Contact BINDER service.
Safety device class 3.1 (option) responds.	Limit temperature reached.	Check setting of temperature set-point and of safety device class 3.1. If appropriate, select suitable limit value.
	Controller defective.	Contact BINDER service.
	Safety device defective.	
Controller		
No entries to controller keypad possible. Notification "KEY LOCK" is displayed	Keyboard locking (option) activated.	Unlock keyboard locking (chap. 11.10).
No access to menu "User settings".	User code incorrect.	Contact BINDER service.
Wrong temperature alarms, disturbance of temperature accuracy	Temperature unit changed to °F.	Set temperature unit to °C (chap. 6.4).
Chart recorder function: measured-value memory cleared, information lost.	New setting of storage rate.	Change the storage rate ONLY if the previously registered data are no longer required (chap. 7).
Controller does not attain set-points entered in Manual Mode.	Button EXIT or AUTOMATIC has been hit: Chamber is in Idle Mode.	Change to Manual Mode (chap. 8).
Controller does not attain program set-points.	Button EXIT or AUTOMATIC has been hit: Chamber is in Idle Mode.	Start the program again (chap. 9.7).
Program duration longer than programmed.	Tolerances have been programmed.	For rapid transition phases, do NOT program tolerance limits in order to allow maximum heating, speed.
Program stops one section too early.	Program line is incomplete.	When programming, define the end value of the desired cycle by adding an additional section with a section time of at least one second.
Display flashing: 1999 or -1999 or 9999.	Sensor rupture between sensor and controller	Contact BINDER service.
	Short-circuit.	
	Initialization problem due to turning on the chamber too early.	Observe a delay time of approx. 30s between turning the chamber Off and On again.

Fault description	Possible cause	Required measures
Miscellaneous		
Fan does not turn	Fan speed set to 0%.	Set the fan speed to the desired value.

	Only qualified service personnel authorized by BINDER must perform repair. Repaired chambers must comply with the BINDER quality standards.
---	---

15. Technical description

15.1 Factory calibration and adjustment

This chamber was calibrated and adjusted in the factory. Calibration and adjustment were performed using standardized test instructions, according to the QM DIN EN ISO 9001 system applied by BINDER (certified since December 1996 by TÜV CERT). All test equipment used is subject to the administration of measurement and test equipment that is also constituent part of the BINDER QM DIN EN ISO 9001 systems. They are controlled and calibrated in relation to a DKD-Standard at regular intervals.

15.2 Definition of usable volume

The usable volume illustrated below is calculated as follows:

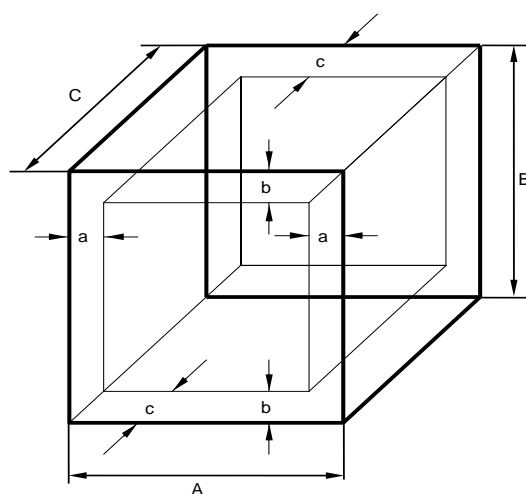

A, B, C = internal dimensions (W, H, D)

a, b, c = wall separation

$$a = 0.1 \cdot A$$

$$b = 0.1 \cdot B$$

$$c = 0.1 \cdot C$$

$$V_{USE} = (A - 2 \cdot a) \cdot (B - 2 \cdot b) \cdot (C - 2 \cdot c)$$

Figure 15: Determination of the useable volume

The technical data refers to the defined usable volume.

	<p>Do NOT place samples outside this usable volume.</p> <p>Do NOT load this volume by more than half to enable sufficient airflow inside the chamber.</p> <p>Do NOT divide the usable volume into separate parts with large area samples.</p> <p>Do NOT place samples too close to each other in order to permit circulation between them and thus obtain a homogenous distribution of temperature.</p>
---	---

15.3 Over current protection

Single-phase devices are protected by a miniature fuse against over current, accessible from the outside. The miniature fuse is located on the right side of the chamber above the strain relief of the power cord. The fuse holder is equipped with a fuse clip 5mm x 20 mm. A fuse may be replaced only with a substitute of the same ratings. Refer to the technical data of the respective device type.

Three-phase devices are equipped with internal fuses not accessible from outside. If these fuses are blown, please inform an electronic engineer or BINDER service.

15.4 Technical data

Chamber size		53	115	240	400	720
Exterior dimensions						
Width, net	mm inch	635 25.00	835 32.87	1035 40.75	1235 48.62	1235 48.62
Height, gross (incl. feet/castors)	mm inch	780 30.71	865 34.06	985 38.78	1185 46.65	1695 66.73
Depth, net	mm inch	575 22.64	645 25.39	745 29.33	765 30.12	865 34.06
Depth, gross (incl. door handle, instrument panel, and exhaust duct)	mm inch	680 26.77	750 29.53	850 33.46	870 34.25	970 38.19
Wall clearance rear (minimum)	mm inch	100 3.94	100 3.94	100 3.94	100 3.94	100 3.94
Wall clearance side (minimum)	mm inch	160 6.30	160 6.30	160 6.30	160 6.30	160 6.30
Exhaust duct, outer diameter	mm inch	52 2.05	52 2.05	52 2.05	52 2.05	52 2.05
Doors						
Number of doors		1	1	2	2	2
Interior dimensions						
Width	mm inch	400 15.75	600 23.62	800 31.50	1000 39.37	1000 39.37
Height	mm inch	400 15.75	480 18.90	600 23.62	800 31.50	1200 47.24
Depth	mm inch	340 13.39	410 16.14	510 20.08	510 20.08	610 24.02
Interior volume	l cu.ft.	53 1.9	115 4.1	240 8.6	400 14.3	720 25.7
Steam space volume	l cu.ft.	77 2.72	158 5.58	308 10.88	498 17.60	869 30.71
Racks						
Quantity of racks (regular)		2	2	2	2	2
Quantity of racks (max.)		5	6	7	10	16
Maximum load per rack	Kg lbs	15 33	20 44	30 66	35 77	45 99
Maximum permitted total load	Kg lbs	40 88	50 110	70 155	90 199	120 265
Weight						
Weight (empty)	Kg lbs	61 135	89 196	131 289	173 382	203 448

Chamber size			53	115	240	400	720
Temperature data							
Temperature range, 5 °C above ambient up to	°C		300	300	300	300	300
	°F		572	572	572	572	572
Temperature fluctuation	≤± K		0.3	0.3	0.3	0.3	0.3
Temperature uniformity (variation)	at 70 °C	± K	0.5	0.6	0.8	0.7	0.7
	at 150 °C	± K	1.3	1.5	1.5	1.5	1.9
	at 300 °C	± K	2.8	2.8	2.8	5	4.6
Heating up time	to 70 °C	min	5	5	6	6	7
	to 150 °C	min	15	16	19	18	21
	to 250 °C	min	35	36	42	44	51
Recovery time after door was opened for 30 sec 2)	to 70 °C	min	1	1	1	1	1
	to 150 °C	min	3	3	3	3	3
	to 300 °C	min	5	5	5	5	5
Air change data							
Air change (air flap open)	at 70 °C	x/h	180	87	57	51	33
	at 150 °C	x/h	192	96	60	54	36
	at 300 °C	x/h	160	78	54	48	29
Electrical data							
IP system of protection acc. to EN 60529			20	20	20	20	20
Nominal voltage (±10 %) 50/60 Hz		V	230 1N~	230 1N~	230 1N~	400 3N~	400 3N~
Nominal power		kW	1.20	1.60	2.70	3.40	5.00
Power plug			shock proof plug	shock proof plug	shock proof plug	CEE plug 5 poles	CEE plug 5 poles
Chamber fuse 5x20 mm / 250V / time-lag T		Amp	10 external	10 external	16 external	---	---
Over-current release category B, 3 poles		Amp	---	---	---	16 internal	16 internal
Installation category acc. to IEC 61010-1			II	II	II	II	II
Pollution degree acc. to IEC 61010-1			2	2	2	2	2
Environment-specific data							
Energy consumption	at 70 °C	Wh/h	145	230	370	520	570
	at 150 °C	Wh/h	300	544	850	1200	1320
	at 300 °C	Wh/h	720	1100	1400	2340	2600

All technical data is specified for unloaded chambers with standard equipment at an ambient temperature of +25 °C / 77 °F and a power supply voltage fluctuation of ±10. Technical data is determined in accordance to BINDER Factory Standard Part 1:2015 following DIN 12880:2007.

All indications are average values, typical for chambers produced in series. We reserve the right to change technical specifications at any time.



If the chamber is fully loaded, the specified heating up times may vary according to the load.

15.5 Equipment and options (extract)



To operate the chamber, use only original BINDER accessories or accessories / components from third-party suppliers authorized by BINDER. The user is responsible for any risk arising from using unauthorized accessories.

Chamber Size	53	115	240	400	720
Regular equipment					
Microprocessor display program controller	●	●	●	●	●
Communication interface RS 422	●	●	●	●	●
Program controlled air flap	●	●	●	●	●
Programmable automatic ventilation	●	●	●	●	●
Exhaust duct Ø 50 mm	●	●	●	●	●
Temperature safety device class 2 acc. to DIN 12880:2007 with optical temperature alarm	●	●	●	●	●
Four castors (2 lockable)	--	--	--	--	●
2 racks, chrome-plated	●	●	●	●	●
Options / accessories					
Access ports, various diameters, with silicone plug	○	○	○	○	○
Rack, chrome-plated or stainless steel	○	○	○	○	○
Perforated rack ,stainless steel	○	○	○	○	○
Securing elements for additional fastening of racks (4 pc.)	○	○	○	○	○
Reinforced rack with rack lockings	--	--	○	○	○
Reinforced inner chamber with 2 reinforced racks	--	--	○	○	○
Temperature safety device class 3.1 acc. to DIN 12880:2007, available via BINDER Individual	○	○	○	○	○
Door(s) with window and interior lighting	○	○	○	○	○
Keyboard locking	○	○	○	○	○
Lockable door	○	○	○	○	○
FKM door gasket (temperature resistant up to 200 °C)	○	○	○	○	○
HEPA Fresh air filter, class H 14 (DIN EN 1822)	○	○	○	○	○
Measurement protocol of air change rate acc. to ASTM D 5374	○	○	○	○	○
Mostly gas-tight version	○	○	--	--	--
Inert gas connection (inlet and outlet) with mostly gas-tight version	○	○	--	--	--
Additional flexible Pt100 temperature sensor with external connection	○	○	○	○	○
Additional measuring channel for digital object temperature display with flexible Pt100 temperature sensor	○	○	○	○	○
Analog output 4-20 mA for temperature with 6 pole DIN socket, DIN plug included	○	○	○	○	○
Data Logger Kit T 350	○	○	○	○	○
Temperature calibration including certificate	○	○	○	○	○
Spatial temperature measurement including certificate	○	○	○	○	○
Qualification folder	○	○	○	○	○
Base on castors	--	○	○	--	--
Sturdy trolley, castors with locking brakes	○	○	○	○	--

Legend: ● Standard equipment ○ Optional -- Not available

15.6 Accessories and spare parts (extract)



BINDER GmbH is responsible for the safety features of the chamber only, provided skilled electricians or qualified personnel authorized by BINDER perform all maintenance and repair, and if components relating to chamber safety are replaced in the event of failure with original spare parts. The user is responsible for any risks arising from using unauthorized accessories/components.

Chamber size	53	115	240	400	720
Description	Art. No.				
Rack, chrome-plated	6004-0002	6004-0003	6004-0004	6004-0005	6004-0006
Rack, stainless steel	6004-0007	6004-0008	6004-0009	6004-0011	6004-0010
Perforated rack, stainless steel	6004-0029	6004-0030	6004-0031	6004-0032	6004-0033
Reinforced rack with rack lockings	--	--	8012-0345	8012-0346	8012-0374
Door gasket silicone	6005-0095	6005-0096	6005-0097	6005-0069	6005-0099
Door gasket made of FKM (temperature resistant up to 200 °C)	8012-0494	8012-0495	8012-0496	8012-0497	8012-0498
Chamber fuse 5x20mm 250V 10A time-lag (T)	5006-0079	5006-0079	--	--	--
Chamber fuse 5x20mm 250V 16A time-lag (T)	--	--	5006-0103	--	--
Sturdy trolley, castors with locking brakes	9051-0018	9051-0018	9051-0019	9051-0019	--

Description	Art. No.
HEPA Fresh air filter, class EU 14H 14 (DIN EN 1822)	8012-0222
Data logger Kit T350	8012-0714
Data logger software, including converter-cable	8012-0821
Rack lockings (4 pieces)	8012-0531
Neutral cleaning agent, 1 kg	1002-0016

For information on components not listed here, please contact BINDER Service.

Validation service	Art. No.
Qualification folder IQ-OQ	8012-0862
Qualification folder IQ-OQ-PQ	8012-0950
Execution of IQ-OQ	DL410200
Execution of IQ-OQ-PQ	DL440500

Calibration service	Art. No.
Calibration of temperature including certificate (1 measuring point)	DL300101
Spatial temperature measurement including certificate (9 measuring points)	DL300109
Spatial temperature measurement including certificate (18 measuring points)	DL300118
Spatial temperature measurement including certificate (27 measuring points)	DL300127
Measurement of air ventilation acc. to ASTM D 5374, including certificate	DL330000

15.7 Dimensions M 53

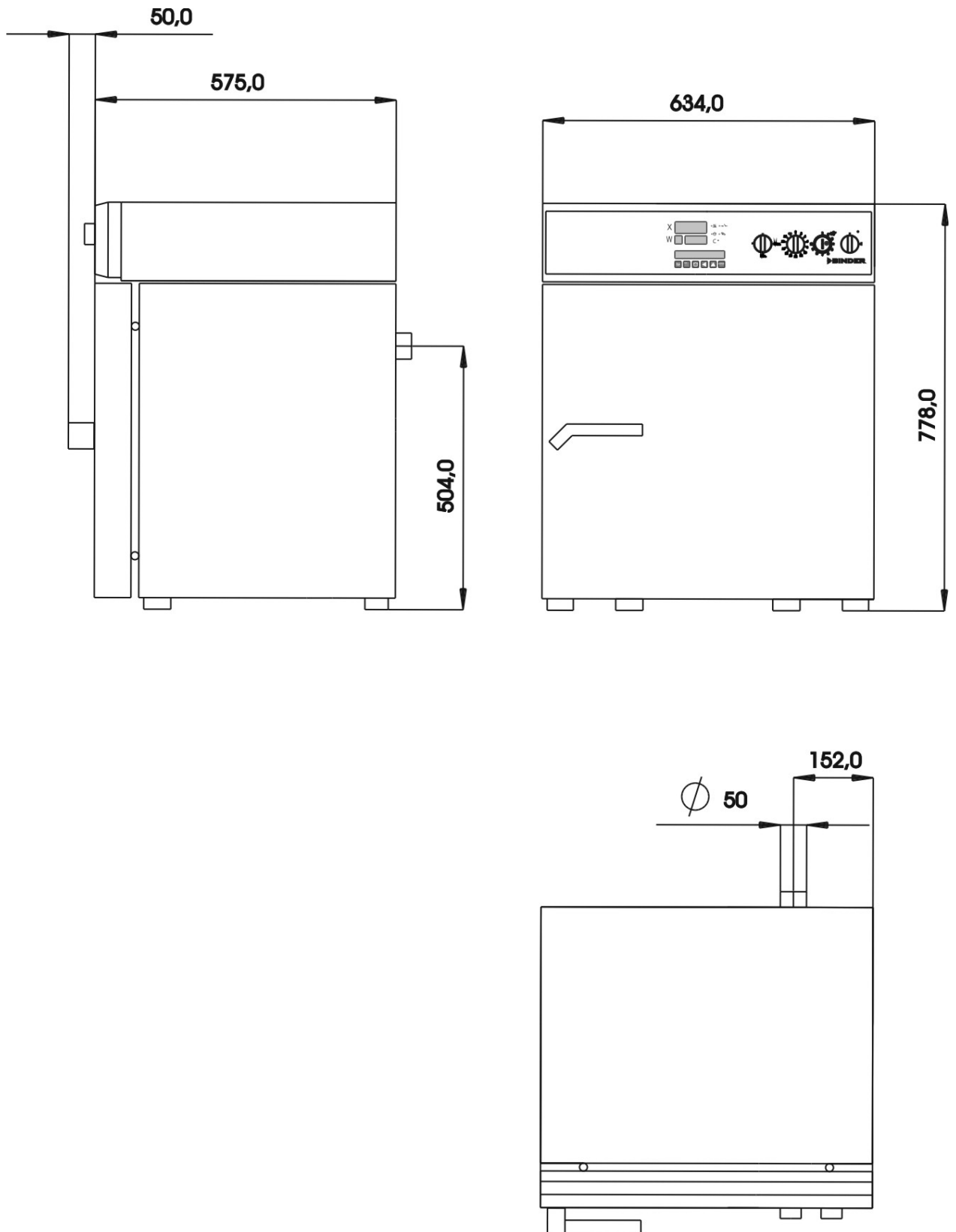

15.8 Dimensions M 115

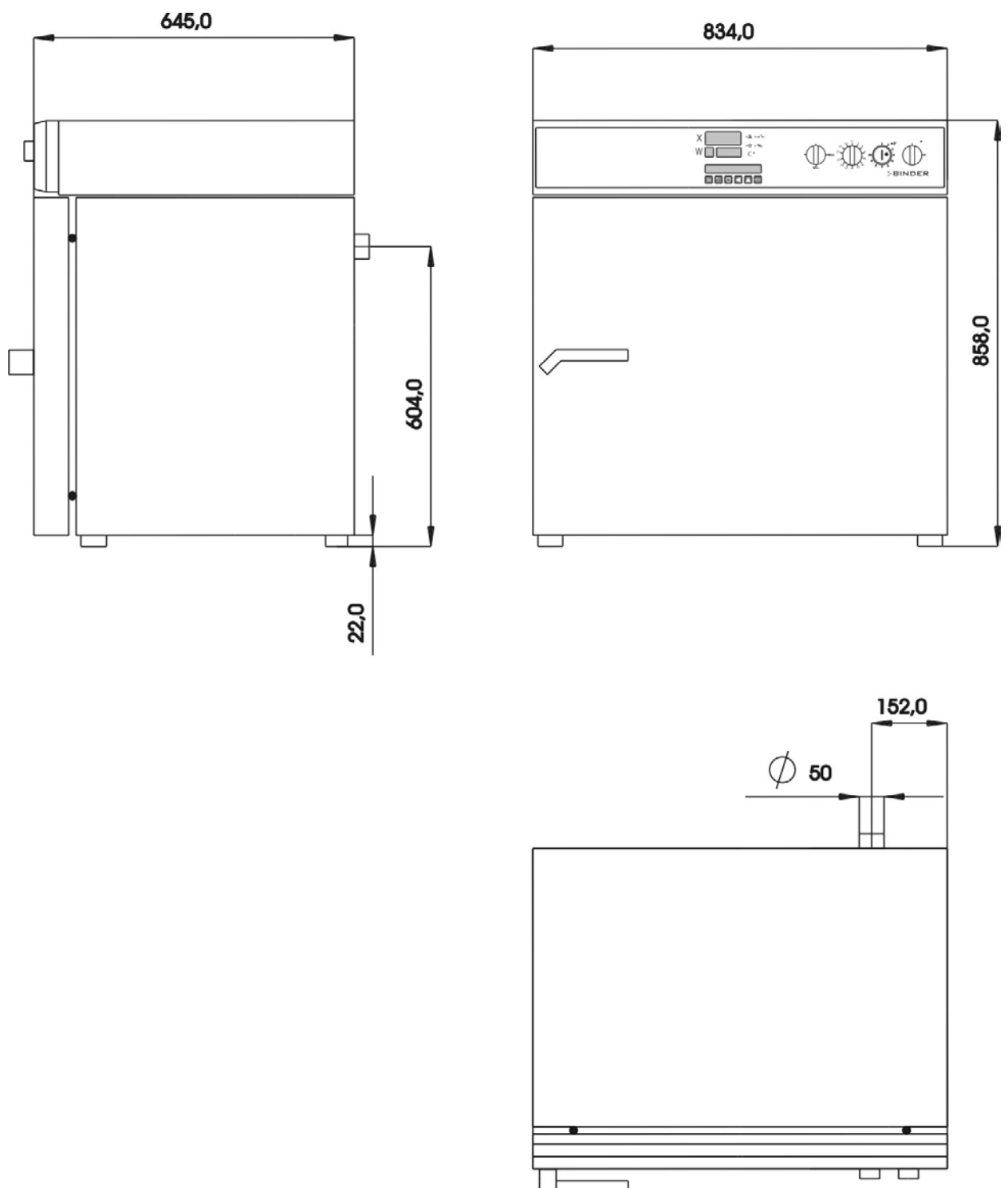

15.9 Dimensions M 240

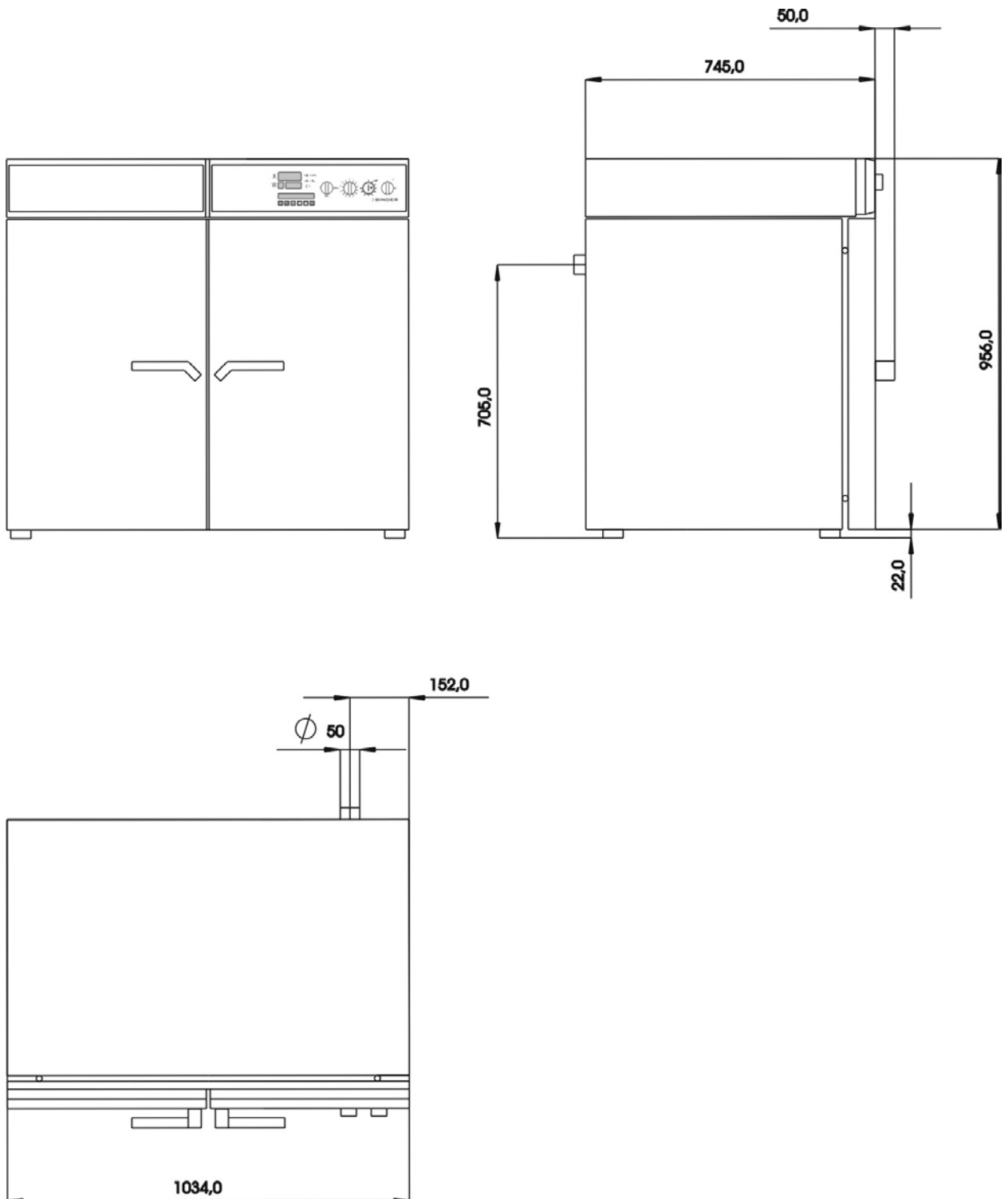

15.10 Dimensions M 400

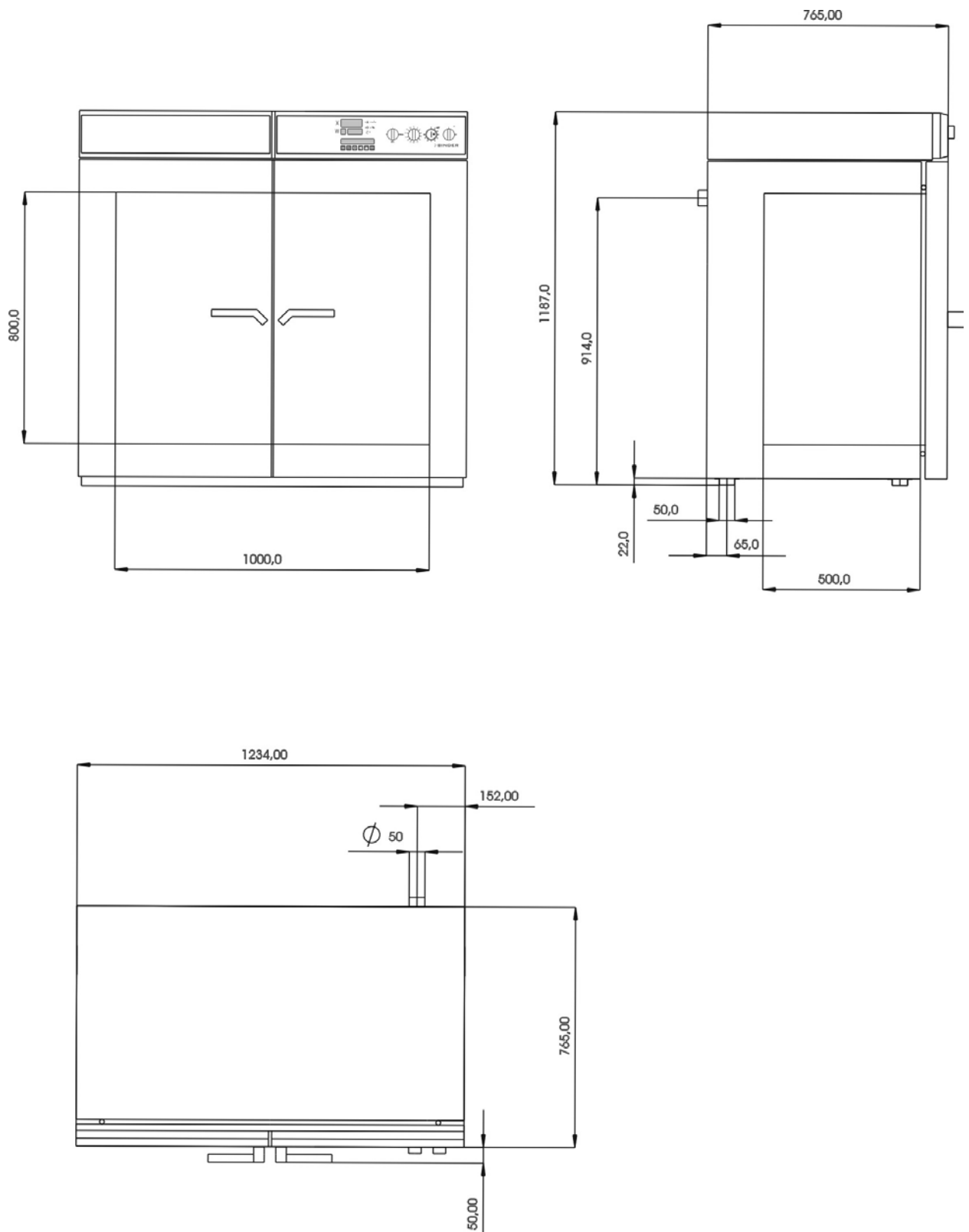

15.11 Dimensions M 720

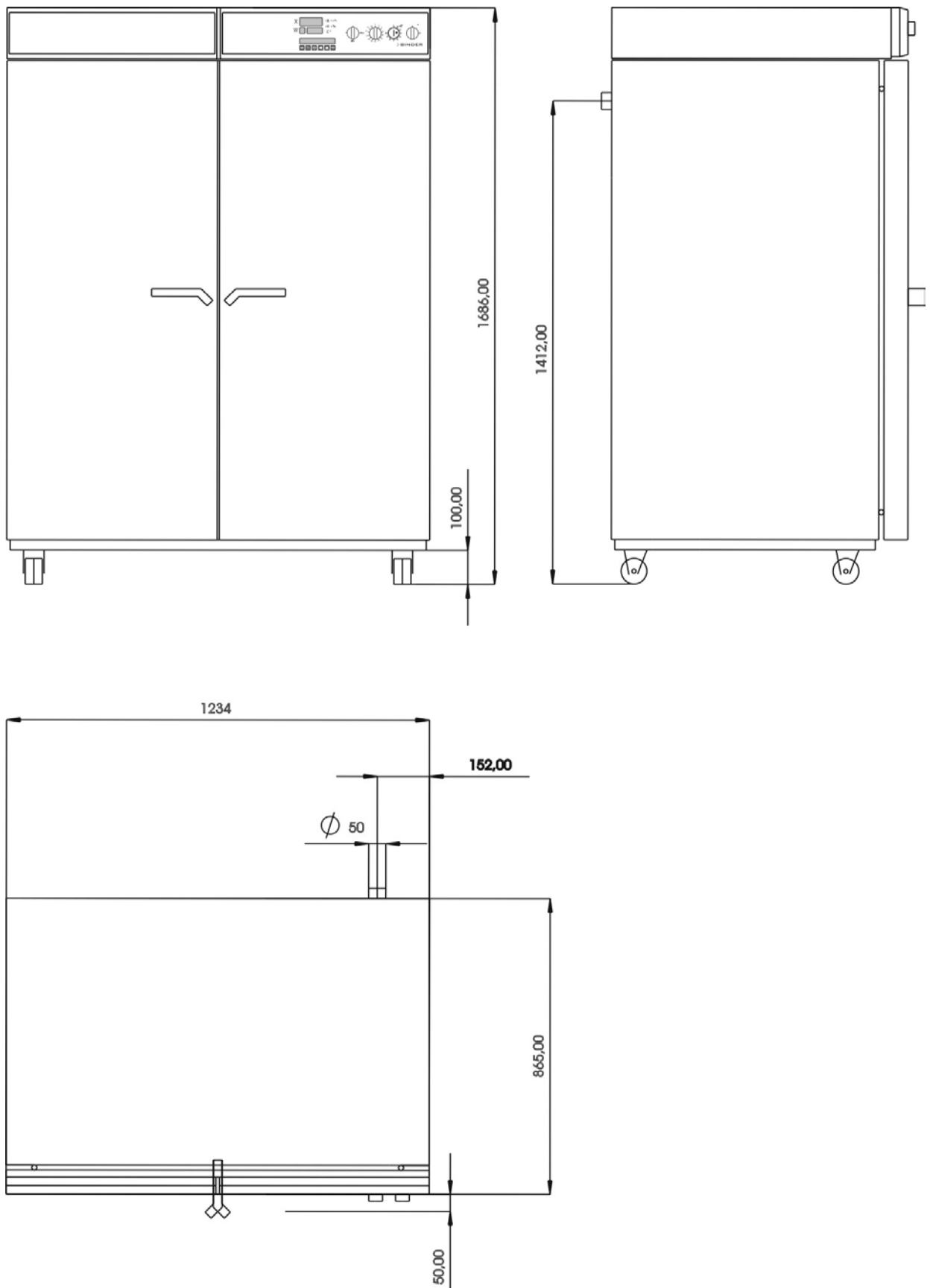

16. EU Declaration of Conformity

CE EU-Konformitätserklärung / EU Declaration of Conformity / Déclaration de conformité UE / Declaración de conformidad UE / Dichiarazione di conformità UE / Декларация соответствия EU

Hersteller / Manufacturer / Fabricant / Fabricante / Fabbricante / Производитель	BINDER GmbH
Anschrift / Address / Adresse / Dirección / Indirizzo / Адрес	Im Mittleren Ösch 5, 78532 Tuttlingen, Germany
Produkt / Product / Produit / Producto / Prodotto / Продукт	Trocken- und Wärmeschränke mit Umluft Drying and heating ovens with forced convection Etuves de chauffage et de séchage à convection forcée Estufas de secado y calentamiento con convección forzada Stufe per essiccazione e riscaldamento a convezione forzata Сушильные и сухожаровые шкафы с принудительной конвекцией
Typenbezeichnung / Type / Type / Tipo / Tipo / Тип	M 53, M 115, M 240, M 400, M 720

Das oben beschriebene Produkt ist konform mit folgenden EU-Richtlinien:

The product described above is in conformity with the following EU Directives:

Le produit décrit ci-dessus est conforme aux directives UE suivantes:

El producto descrito arriba cumple con las siguientes directivas de la UE:

Il prodotto sopra descritto è conforme alle seguenti direttive UE:

Продукты, указанные выше, полностью соответствуют следующим EU руководствам:

- 2014/35/EU**
 Niederspannungsrichtlinie 2014/35/EU / Low voltage directive 2014/35/EU / Directive basse tension 2014/35/UE / Directiva sobre baja tensión 2014/35/UE / Direttiva Bassa tensione 2014/35/UE / Директива по низкому напряжению 2014/35/EU
- 2014/30/EU**
 EMV-Richtlinie 2014/30/EU / EMC Directive 2014/30/EU / Directive CEM 2014/30/UE / Directiva CEM 2014/30/UE / Direttiva EMC 2014/30/UE / Директива ЭМС 2014/30/EU
- 2011/65/EU**
 RoHS-Richtlinie 2011/65/EU / RoHS Directive 2011/65/EU / Directive RoHS 2011/65/UE / Directiva RoHS 2011/65/UE / Direttiva RoHS 2011/65/UE / Директива RoHS 2011/65/EU

Die oben beschriebenen Produkte tragen entsprechend die Kennzeichnung CE.

The products described above, corresponding to this, bear the CE-mark.

Les produits décrits ci-dessus, en correspondance, portent l'indication CE.

Los productos descritos arriba, en conformidad, llevan la indicación CE.

I prodotti sopra descritti, conformi a quanto sopra, portano il marchio CE.

Данные продукты в соответствии с изложенным выше маркированы знаком CE.

1 / 2

BINDER GmbH Postfach 102 D-78502 Tuttlingen **Address:** BINDER GmbH Im Mittleren Ösch 5 78532 Tuttlingen Germany
Contact: Phone: +49 (0) 74 62 / 20 05 - 0 | Fax: +49 (0) 74 62 / 20 05 - 100 | info@binder-world.com | www.binder-world.com
Managing Director: Dipl.-Ing. Peter M. Binder | District court Stuttgart, HRB 727150 | Company head office: Tuttlingen Germany
Payment Details: Kreissparkasse Tuttlingen Account no.: 2266 | BAN: 643 500 70 | IBAN-Code: DE05643 500700 000002266 | SWIFT-Code: SOLA DE S1TUT
 \$-Account no. 2202 611 55 | IBAN-Code: DE7464350070 0220 261155 | SWIFT-Code: SOLA DE S1TUT
 Deutsche Bank Tuttlingen Account no.: 2 138 709 | BAN: 653 700 75 | IBAN-Code: DE56653 70075 0213870900 | SWIFT-Code: DEUT DE SS630
 Recycling of old equipment according to WEEE-Reg.-no. DE 37004983

Die oben beschriebenen Produkte sind konform mit folgenden harmonisierten Normen:
The products described above are in conformity with the following harmonized standards:
Les produits décrits ci-dessus sont conformes aux normes harmonisées suivantes:
Los productos descritos arriba cumplen con las siguientes normas:
I prodotti sopra descritti sono conformi alle seguenti normative armonizzate:
Продукты, указанные выше, полностью соответствуют следующим стандартам:

Sicherheit / Safety / Sécurité / Seguridad / Sicurezza / Нормативы по безопасности
<ul style="list-style-type: none">• EN 61010-1:2010• EN 61010-2-010:2014
EMV / EMC / CEM / CEM / EMC / ЭМС
<ul style="list-style-type: none">• EN 61326-1:2013
RoHS
<ul style="list-style-type: none">• EN 50581:2012

78532 Tuttlingen, 03.07.2017

BINDER GmbH



P. M. Binder
Geschäftsführender Gesellschafter
Managing Director
Directeur général
Director general
Direttore Generale
Директор



J. Bollaender
Leiter F & E
Director R & D
Chef de service R&D
Responsable I & D
Direttore R & D
Глава департамента R&D

2 / 2

17. Product registration

Online Product Registration

Register your BINDER now!

www.binder-world.com/register

The registration is free and takes just a few seconds

Advantages:

- ▶ Short response times if service is needed
- ▶ Fair prices when relocating or installing equipment
- ▶ Calibration as required at no charge in case of recalls
- ▶ Free information on news, product upgrades and accessories

Easy registered in 3 steps:



1. List serial number here: -

2. Go online: www.binder-world.com/register

3. Register serial number

18. Contamination clearance certificate

Unbedenklichkeitsbescheinigung

18.1 For chambers located outside the USA and Canada

Declaration regarding safety and health

Erklärung zur Sicherheit and gesundheitlichen Unbedenklichkeit

The German Ordinance on Hazardous Substances (GefStofV), and the regulations regarding safety at the workplace, require that this form be filled out for all products that are returned to us, so that the safety and the health of our employees can be guaranteed.

Die Sicherheit und Gesundheit unserer Mitarbeiter, die Gefahrstoffverordnung GefStofV und die Vorschriften zur Sicherheit am Arbeitsplatz machen es erforderlich, dass dieses Formblatt für alle Produkte, die an uns zurückgeschickt wird.



Note: A repair is not possible without a completely filled out form.
Ohne Vorliegen des vollständig ausgefüllten Formblattes ist eine Reparatur nicht möglich.

- A completely filled out form must be transmitted via Fax (+49 (0) 7462 2005 93555) or by letter in advance, so that this information is available before the equipment/component part arrives. A second copy of this form must accompany the equipment/component part. In addition, the carrier should be notified.

Eine vollständig ausgefüllte Kopie dieses Formblattes soll per Telefax (Nr. +49 (0) 7462 2005 93555) oder Brief vorab an uns gesandt werden, so dass die Information vorliegt, bevor das Gerät/Bauteil eintrifft. Eine weitere Kopie soll dem Gerät/Bauteil beigelegt sein. Ggf. ist auch die Spedition zu informieren.

- Incomplete information or non-conformity with this procedure will inevitably lead to substantial delays in processing. Please understand the reason for this measure, which lies outside our area of influence and will help us to speed up this procedure.

Unvollständige Angaben oder Nichteinhalten dieses Ablaufs führen zwangsläufig zu beträchtlichen Verzögerungen in der Abwicklung. Bitte haben Sie Verständnis für Maßnahmen, die außerhalb unserer Einflussmöglichkeiten liegen und helfen Sie mit, den Ablauf beschleunigen.

- **Please print and fill out this form completely.**

Bitte unbedingt vollständig ausfüllen!

1. Unit/ component part / type: / Gerät / Bauteil / Typ:
2. Serial No./ Serien-Nr.:
3. Details about utilized substances / biological substances / Einzelheiten über die eingesetzten Substanzen/biologische Materialien:
3.1 Designations / Bezeichnungen:
a) _____
b) _____
c) _____
3.2 Safety measures required for handling these substances / Vorsichtsmaßnahmen beim Umgang mit diesen Stoffen:
a) _____
b) _____
c) _____

3.3 Measures to be taken in case of skin contact or release into the atmosphere / Maßnahmen bei Personenkontakt oder Freisetzung:
a) _____
b) _____
c) _____
d) _____
3.4 Other important information that must be taken into account / Weitere zu beachtende und wichtige Informationen:
a) _____
b) _____
c) _____
4. Declaration on the risk of these substances (please checkmark the applicable items) / Erklärung zur Gefährlichkeit der Stoffe (bitte Zutreffendes ankreuzen) :
<input type="checkbox"/> 4.1 For non toxic, non radioactive, biologically harmless materials / für nicht giftige, nicht radioaktive, biologisch ungefährliche Stoffe:
We hereby guarantee that the above-mentioned unit / component part... / Wir versichern, dass o.g. Gerät/Bauteil...
<input type="checkbox"/> Has not been exposed to or contains any toxic or otherwise hazardous substances / weder giftige noch sonstige gefährliche Stoffe enthält oder solche anhaften.
<input type="checkbox"/> That eventually generated reaction products are non-toxic and also do not represent a hazard / auch evtl. entstandene Reaktionsprodukte weder giftig sind noch sonst eine Gefährdung darstellen.
<input type="checkbox"/> Eventual residues of hazardous substances have been removed / evtl. Rückstände von Gefahrstoffen entfernt wurden.
<input type="checkbox"/> 4.2 For toxic, radioactive, biologically harmful or hazardous substances, or any other hazardous materials / für giftige, radioaktive, biologisch bedenkliche bzw. gefährliche Stoffe oder anderweitig gefährliche Stoffe.
We hereby guarantee that ... / Wir versichern, dass ...
<input type="checkbox"/> The hazardous substances, which have come into contact with the above-mentioned equipment/component part, have been completely listed under item 3.1 and that all information in this regard is complete / die gefährlichen Stoffe, die mit dem o.g. Gerät/Bauteil in Kontakt kamen, in 3.1 aufgelistet sind und alle Angaben vollständig sind.
<input type="checkbox"/> That the unit /component part has not been in contact with radioactivity / das Gerät/Bauteil nicht mit Radioaktivität in Berührung kam
5. Kind of transport / transporter / Transportweg/Spediteur:
Transport by (means and name of transport company, etc.) Versendung durch (Name Spediteur o.ä.)

Date of dispatch to BINDER GmbH / Tag der Absendung an BINDER GmbH:

We hereby declare that the following measures have been taken / Wir erklären, dass folgende Maßnahmen getroffen wurden:

- Hazardous substances were removed from the unit including component parts, so that no hazard exists for any person in the handling or repair of these items / das Gerät/Bauteil wurde von Gefahrstoffen befreit, so dass bei Handhabung/Reparaturen für die betreffende Person keinerlei Gefährdung besteht
- The unit was securely packaged and properly identified / das Gerät wurde sicher verpackt und vollständig gekennzeichnet.
- Information about the hazardousness of the shipment (if required) has been provided to the transporter / der Spediteur wurde (falls vorgeschrieben) über die Gefährlichkeit der Sendung informiert.

We hereby commit ourselves and guarantee that we will indemnify BINDER GmbH for all damages that are a consequence of incomplete or incorrect information provided by us, and that we will exempt BINDER GmbH from eventual damage claims by third parties./ Wir versichern, dass wir gegenüber BINDER für jeden Schaden, der durch unvollständige und unrichtige Angaben entsteht, haften und BINDER gegen eventuell entstehende Schadenansprüche Dritter freistellen.

We are aware that, in accordance with Article 823 of the German Civil Code (BGB), we are directly liable with regard to third parties, in this instance especially the employees of BINDER GmbH, who have been entrusted with the handling / repair of the unit / component. / Es ist uns bekannt, dass wir gegenüber Dritten – hier insbesondere mit der Handhabung/Reparatur des Geräts/des Bauteils betraute Mitarbeiter der Firma BINDER - gemäß §823 BGB direkt haften

Name: _____

Position / Title: _____

Date / Datum: _____

Signature / Unterschrift: _____

Company stamp / Firmenstempel:



Equipment that is returned to the factory for repair must be accompanied by a completely filled out contamination clearance certificate. For service and maintenance on site, such a contamination clearance certificate must be submitted to the service technician before the start of any work. No repair or maintenance of the equipment is possible, without a properly filled out contamination clearance certificate.

18.2 For chambers located in the USA and Canada

Product Return Authorization Request

Please complete this form and the Customer Decontamination Declaration (next 2 pages) and attach the required pictures. E-mail to: IDL_SalesOrderProcessing_USA@binder-world.com

After we have received and reviewed the complete information we will decide on the issue of a RMA number. Please be aware that size specifications, voltage specifications as well as performance specifications are available on the internet at www.binder-world.us at any time.

Take notice of shipping laws and regulations.

	Please fill:	
Reason for return request	<input type="radio"/> Duplicate order	
	<input type="radio"/> Duplicate shipment	
	<input type="radio"/> Demo	<i>Page one completed by sales</i>
	<input type="radio"/> Power Plug / Voltage	115V / 230 V / 208 V / 240V
	<input type="radio"/> Size does not fit space	
	<input type="radio"/> Transport Damage	Shock watch tripped? (<i>pictures</i>)
	<input type="radio"/> Other (specify below)	

Is there a replacement PO?	<input type="radio"/> Yes <input type="radio"/> No	
<i>If yes -> PO #</i>		
<i>If yes -> Date PO placed</i>		
Purchase order number		
BINDER model number		
BINDER serial number		
Date unit was received		
Was the unit unboxed?	<input type="radio"/> Yes <input type="radio"/> No	
Was the unit plugged in?	<input type="radio"/> Yes <input type="radio"/> No	
Was the unit in operation?	<input type="radio"/> Yes <input type="radio"/> No	
<i>Pictures of unit attached?</i>	<input type="radio"/> Yes <input type="radio"/> No	Pictures have to be attached!
<i>Pictures of Packaging attached?</i>	<input type="radio"/> Yes <input type="radio"/> No	

	Customer Contact Information	Distributor Contact Information
Name		
Company		
Address		
Phone		
E-mail		

Customer (End User) Decontamination Declaration

Health and Hazard Safety declaration

To protect the health of our employees and the safety at the workplace, we require that this form is completed by the user for all products and parts that are returned to us. (Distributors or Service Organizations cannot sign this form)

	<p>NO RMA number will be issued without a completed form. Products or parts returned to our NY warehouse without a RMA number will be refused at the dock.</p>
---	--

A second copy of the completed form must be attached to the outside of the shipping box.

1.	Unit/ component part / type:
2.	Serial No.
3.	List any exposure to hazardous liquids, gasses or substances and radioactive material
3.1	List with MSDS sheets attached where available or needed (if there is not enough space available below, please attach a page):
a)	_____
b)	_____
c)	_____
3.2	Safety measures required for handling the list under 3.1
a)	_____
b)	_____
c)	_____
3.3	Measures to be taken in case of skin contact or release into the atmosphere:
a)	_____
b)	_____
c)	_____
d)	_____
3.4	Other important information that must be considered:
a)	_____
b)	_____
c)	_____

4. Declaration of Decontamination

For toxic, radioactive, biologically and chemically harmful or hazardous substances, or any other hazardous materials.

We hereby guarantee that

- 4.1 Any hazardous substances, which have come into contact with the above-mentioned equipment / component part, have been completely listed under item 3.1 and that all information in this regard is complete.
- 4.2 That the unit /component part has not been in contact with radioactivity
- 4.3 Any Hazardous substances were removed from the unit / component part, so that no hazard exists for a persons in the shipping, handling or repair of these returned unit
- 4.4 The unit was securely packaged in the original undamaged packaging and properly identified on the outside of the packaging material with the unit designation, the RMA number and a copy of this declaration.
- 4.5 Shipping laws and regulations have not been violated.

I hereby commit and guarantee that we will indemnify BINDER Inc. for all damages that are a consequence of incomplete or incorrect information provided by us, and that we will indemnify and hold harmless BINDER Inc. from eventual damage claims by third parties.

Name: _____

Position: _____

Company: _____

Address: _____

Phone #: _____

Email: _____

Date: _____

Signature: _____



Equipment returned to the NY warehouse for repair must be accompanied by a completed customer decontamination declaration. For service and maintenance works on site, such a customer decontamination declaration must be submitted to the service technician before the start of work. No repair or maintenance of the equipment is possible without a completed form.