



Compressor-cooled incubator ICP450eco

Ideal for ramp operation with rapid temperature changes during incubation, breeding or storage.



With the help of our model selection, with dimensioned model sketches and extensive technical data for download, you can find the right cooled incubator for your needs. For small volumes and for work predominantly in the proximity of the ambient temperature, the Memmert Peltier-cooled incubator is recommended. Flexibility and technical features of our appliances meet all possible needs. Put us to the test!

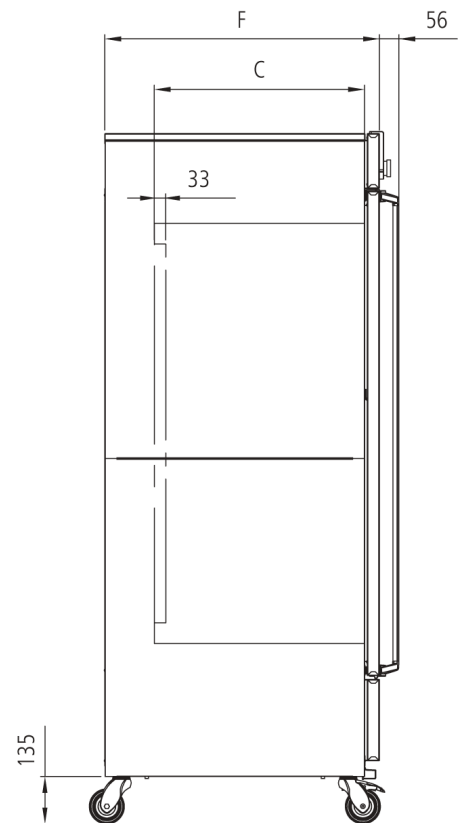
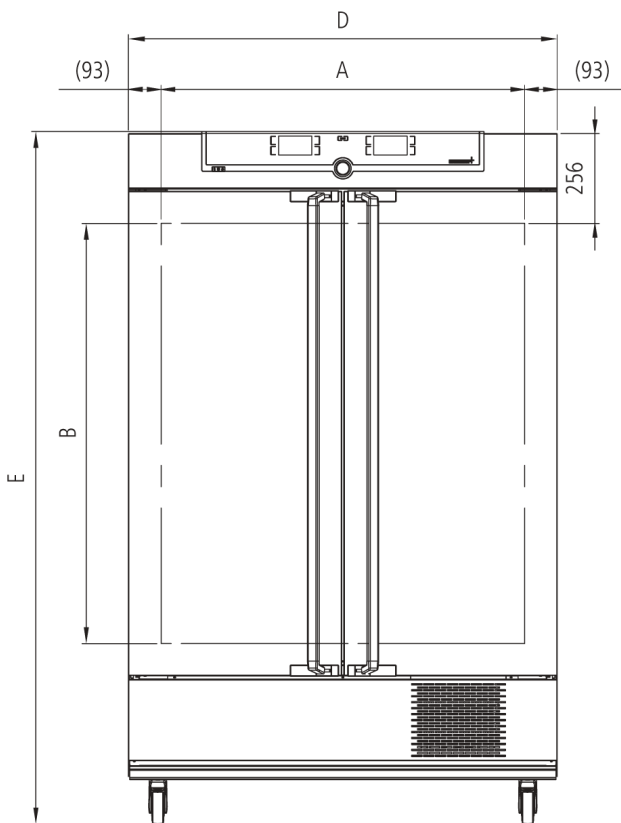

Temperature

Working-temperature range	from -12°C up to +60°C (Optimum performance of cooling aggregate at an ambient temperature of +16°C up to +32°C. Not suitable for long-term storing at sub-zero temperatures. During permanent operation, the glass door may ice over.)
Setting accuracy temperature	0.1 °C
Temperature	2 Pt100 sensors DIN Class A in 4-wire-circuit for mutual monitoring, taking over functions in case of an error

Control technology

ControlCOCKPIT	TwinDISPLAY. Adaptive multifunctional digital PID-microprocessor controller with 2 high-definition TFT-colour displays.
Language setting	German, English, Spanish, French, Polish, Czech, Hungarian
Timer	Digital backwards counter with target time setting, adjustable from 1 minute to 99 days
Function SetpointWAIT	the process time does not start until the set temperature is reached
Calibration	three freely selectable temperature values
adjustable parameters	temperature (Celsius or Fahrenheit), fan speed, programme time, time zones, summertime/wintertime

Communication

Documentation	programme stored in case of power failure
Programming	AtmoCONTROL software on a USB stick for programming, managing and transferring programmes via Ethernet interface or USB port

Safety

Temperature control	mechanical temperature limiter TB, protection class 1 according to DIN 12880 to switch off the heating approx. 10°C above nominal temperature
Temperature control	over- and undertemperature monitor TWW, protection class 3.3 or adjustable temperature limiter TWB, protection class 2, selectable on display
AutoSAFETY	additionally integrated over- and undertemperature protection "ASF", automatically following the setpoint value at a preset tolerance range, alarm in case of over- or undertemperature, heating is switched off in case of overtemperature, compressor in case of undertemperature
Autodiagnostic system	for fault analysis
Alarm	visual and acoustic

Heating concept

Cooling	Cooling compressor with climate-neutral refrigerant CO2 (R744), GWP1
Air jacket	air jacket heating system for gentle all-around heating
Heating concept	no drying-up of the load caused by the cooling device due to separation of thermal jacket from interior
Defrosting	highly efficient automatic defrosting system

Standard equipment

Internals	2 stainless steel grid(s), electropolished
Works calibration certificate	for +10°C and +37°C
Door	inner glass doors
Door	fully insulated stainless steel doors with 2-point locking (compression door lock)

Stainless steel interior

Volume	449 l
Dimensions	$w_{(A)} \times h_{(B)} \times d_{(C)}$: 1040 x 720 x 600 mm
Max. number of internals	8
Max. loading of chamber	200 kg
Max. loading per internal	30 kg

Textured stainless steel casing

Installation	on lockable castors
Dimensions	$w_{(D)} \times h_{(E)} \times d_{(F)}$: 1224 x 1613 x 784 mm
Housing	rear zinc-plated steel

Electrical data

Voltage	230 V, 50/60 Hz
Electrical load	approx. 1200 W
Voltage	115 V, 50/60 Hz
Electrical load	approx. 1200 W

Ambient conditions

Set Up	The distance between the wall and the rear of the appliance must be at least 15 cm. The clearance from the ceiling must not be less than 20 cm and the side clearance from walls or nearby appliances must not be less than 5 cm.
Ambient temperature	15 °C to 28 °C (up to 34 °C with limited temperaturerange)
Humidity rh	max. 70 %, non-condensing
Altitude of installation	max. 2,000 m above sea level
Overvoltage category	II
Pollution degree	2

Packing/shipping data

Transport information	The appliances must be transported upright
Customs tariff number	8419 8998
Country of origin	Federal Republic of Germany
WEEE-Reg.-No.	DE 66812464
Dimensions approx incl. carton	w x h x d: 1330 x 1700 x 1050 cm
Net weight	approx. 222 kg
Gross weight carton	approx. 287 kg

Climate-neutral refrigerant CO₂ ensures better cooling performance

An ICP^{eco} is not only environmentally-friendly, but also virtually maintenance-free and extremely powerful. Compared to appliances with R134a as refrigerant, it has faster temperature change rates during cooling-down. The refrigerant used in Memmert ICH^{eco}/ICP^{eco} appliances with the abbreviation R744 and the chemical molecular formula CO₂ is practically climate-neutral. In addition, R744 does not contain chlorine, is neither flammable nor toxic, does not cause ozone depletion in the atmosphere and does not need to be disposed of or recycled. Memmert cooled incubators ICP with refrigerant R134a will be available in parallel for a transitional period.

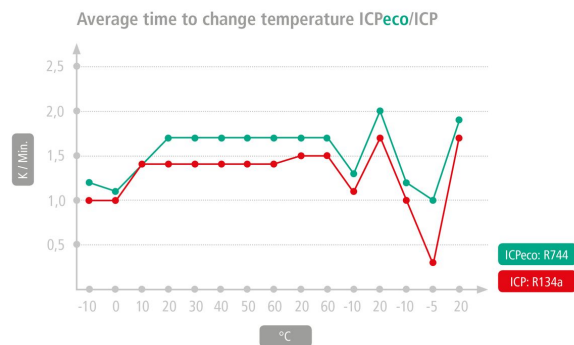

Standard units are safety-approved and bear the test marks

