

Peltier-cooled incubator IPP2200eco

Sets eco standards for cultivation below room temperature: unmatched energy efficiency, best values for heat-up, cool-down and recovery times.

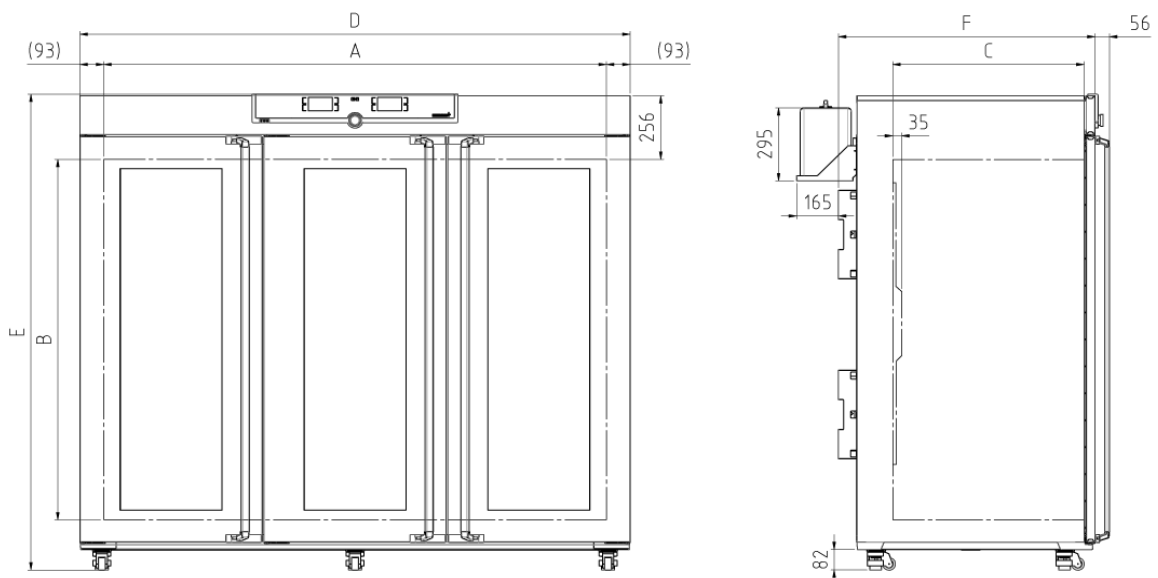

With the help of our model selection, dimensional model sketches and extensive technical data for download, you will find your perfect Peltier-cooled incubator. Flexibility and technical features of our appliances meet all possible needs. Put us to the test!



Temperature

Setting temperature range	0 to +70 °C
Working temperature range	without light: from 0 (at least 20 below ambient temperature) to +70°C
Setting accuracy temperature	0.1 °C
Temperature sensor	1 Pt100 sensor DIN class A in 4-wire-circuit

Control technology

Language setting	German, English, Spanish, French, Polish, Czech, Hungarian
ControlCOCKPIT	SingleDISPLAY. Adaptive multifunctional digital PID-microprocessor controller with high-definition TFT-colour display
Timer	Digital backwards counter with target time setting, adjustable from 1 minute to 99 days
Function SetpointWAIT	the process time does not start until the set temperature is reached
Calibration	three freely selectable temperature values
adjustable parameters	temperature (Celsius or Fahrenheit), programme time, time zones, summertime/wintertime

Ventilation

Convection	forced ventilation by Peltier fan
-------------------	-----------------------------------

Communication

Documentation	programme stored in case of power failure
Programming	AtmoCONTROL software for reading out, managing and organising the data logger via Ethernet interface (temporary trial version can be downloaded). USB stick with AtmoCONTROL software available as accessory (on demand).

Safety

Temperature control	adjustable electronic overtemperature monitor and mechanical temperature limiter
Autodiagnostic system	for fault analysis

Heating concept

Peltier	energy-saving Peltier heating-/cooling system integrated in the rear (heat pump principle)
----------------	--

Standard equipment

Works calibration certificate	for +25 °C and +40 °C
Internals	6 stainless steel grid(s), electropolished
Door	Stainless steel doors with glass sectors, fully heated inner glass panes integrated in the full-sight glass door with 2-point locking (compression door lock)

Stainless steel interior

Dimensions	$w_{(A)} \times h_{(B)} \times d_{(C)}$: 1972 x 1450 x 750 mm (d less 32 mm for fan - Peltier)
Volume	2140 l
Max. number of internals	42
Max. loading of chamber	330 kg
Max. loading per internal	30 kg

Textured stainless steel casing

Dimensions	$w_{(D)} \times h_{(E)} \times d_{(F)}$: 2157 x 1913 x 905 mm (d +56mm door handle & +111mm Peltier element)
Installation	on lockable castors, adjustable in height
Housing	rear zinc-plated steel

Electrical data

Voltage	230 V, 50/60 Hz
Electrical load	approx. 1800 W

Ambient conditions

Set Up	The distance between the wall and the rear of the appliance must be at least 15 cm. The clearance from the ceiling must not be less than 20 cm and the side clearance from walls or nearby appliances must not be less than 5 cm.
Ambient temperature	16 °C to 40 °C
Humidity rh	max. 70 %, non-condensing
Altitude of installation	max. 2,000 m above sea level
Overvoltage category	II
Pollution degree	2

Packing/shipping data

Transport information	The appliances must be transported upright
Customs tariff number	8419 8998
Country of origin	Federal Republic of Germany
WEEE-Reg.-No.	DE 66812464
Dimensions approx incl. carton	w x h x d: 2300 x 2200 x 1190 mm
Net weight	approx. 473 kg
Gross weight carton	approx. 717 kg

Standard units are safety-approved and bear the test marks

