



memmert
Experts in Thermostatics

UN^{PLUS} UF^{PLUS}
IN^{PLUS} IF^{PLUS}
SN^{PLUS} SF^{PLUS}



OPERATING INSTRUCTIONS

UNIVERSAL OVEN U
INCUBATOR I
STERILISER S

100% ATMOSAFE. MADE IN GERMANY.

www.memmert.com | www.atmosafe.net

Manufacturer and customer service

Memmert GmbH + Co. KG
Willi Memmert Straße 90-96
D-91186 Büchenbach
Deutschland

Phone: +49 (0)9122 925-0
Fax: +49 (0)9122 14585
E-mail: sales@memmert.com
Internet: www.memmert.com

Customer service:

Service hotline: +49 (0)9171 9792 911
Service fax: +49 (0)9171 9792 979
E-mail: service@memmert.com

When contacting customer service, always quote the product serial number on the nameplate (see page 13).

Shipping address for repairs:

Memmert GmbH + Co. KG
Kundenservice
Willi-Memmert-Str. 90-96
DE-91186 Büchenbach
Germany

Please contact our customer service before sending appliances for repair or before returning equipment, otherwise, we have to refuse acceptance of the shipment.

© 2014 MEMMERT GmbH + Co. KG

Date 03/2014

We reserve the right to make changes

About this manual

Purpose and target group

This manual describes the setup, function, transport, operation and maintenance of universal ovens UN^{PLUS}/UF^{PLUS}, sterilisers SN^{PLUS}/SF^{PLUS} and incubators IN^{PLUS}/IF^{PLUS}. It is intended for use by trained personnel of the owner, who have the task of operating and/or maintaining the respective appliance.

If you are asked to work on the appliance, read this manual carefully before starting. Familiarise yourself with the safety regulations. Only perform work that is described in this manual. If there is something you do not understand, or certain information is missing, ask your superior or contact the manufacturer. Do not do anything without authorisation.

Versions

The appliances are available in different configurations and sizes. If specific equipment features or functions are available only for certain configurations, this is indicated at the relevant points in this manual.

The functions described in this manual refer to the latest firmware version.

Due to individual configurations and sizes, illustrations in this manual may be slightly different from the actual appearance. Function and operation are identical.

Other documents that have to be observed:

- ▶ For operation of the appliance with MEMMERT AtmoCONTROL, observe the respective software manual
- ▶ For service and repair (see page 55), please refer to the separate service manual

Storage and forwarding

This instruction manual belongs with the appliance and should always be stored where persons working on the appliance have access to it. It is the responsibility of the owner to ensure that persons who are working or will work on the appliance are informed as to the whereabouts of this instruction manual. We recommend that it is always stored in a protected location close to the appliance. Make sure that the instruction manual is not damaged by heat or humidity. If the appliance is sold on or transported and then set up again at a different location, the operating instructions must go with it.

You will find the current version of our operating manual as pdf file if you go to www.memmert.com/de/service/downloads/bedienungsanleitung/.

Contents

1. Safety regulations	6
1.1 Terms and signs used	6
1.1.1 Terms used	6
1.1.2 Signs used	6
1.2 Product safety and dangers	7
1.3 Requirements of the operating personnel	7
1.4 Responsibility of the owner	8
1.5 Intended use	8
1.6 Changes and alterations	9
1.7 Behaviour in case of malfunctions and irregularities	9
1.8 Switching off the appliance in an emergency	9
2. Construction and description	10
2.1 Construction	10
2.2 Function	11
2.3 Material	11
2.4 Electrical equipment	11
2.5 Connections and interfaces	12
2.5.1 Electrical connection	12
2.5.2 Communication interfaces	12
2.6 Designation (nameplate)	13
2.7 Technical data	14
2.8 Applied directives and standards	15
2.9 Declaration of conformity	15
2.10 Ambient conditions	16
2.11 Scope of delivery	16
2.12 Optional accessories	16
3. Delivery, transport and setting up	17
3.1 Safety regulations	17
3.2 Delivery	17
3.3 Transport	17
3.4 Unpacking	17
3.4.1 Checking for completeness and transport damage	17
3.4.2 Disposing of packaging material	17
3.5 Storage after delivery	18
3.6 Setting up	18
3.6.1 Prerequisites	18
3.6.2 Installation options	19
3.6.3 Tilt protection	20
4. Putting into operation	21
4.1 Connecting the appliance	21
4.2 Switching on	21
5. Operation and control	22
5.1 Operating personnel	22
5.2 Opening the door	22
5.3 Loading the appliance	23
5.4 Operating the appliance	23
5.4.1 ControlCOCKPIT	23
5.4.2 Basic operation	25
5.4.3 Operating modes	25

5.4.4	Manual mode	26
5.4.5	Timer operation	27
5.4.6	Programme mode	28
5.5	Temperature monitoring	29
5.5.1	Electronic temperature monitoring (TWW)	30
5.5.2	Electronic temperature limiter (TWB) protection class 2 acc. to DIN 12 880	31
5.5.3	Automatic temperature monitor (ASF)	32
5.5.4	Mechanical temperature monitoring: Temperature limiter (TB)	32
5.5.5	Adjusting temperature monitoring	32
5.6	Graph	34
5.7	Ending operation	34
6.	Malfunctions, warning and error messages	35
6.1	Warning messages of the monitoring function	35
6.1.1	Temperature monitoring	35
6.2	Malfunctions, operating problems and appliance errors	36
6.3	Power failure	37
7.	Menu mode	38
7.1	Overview	38
7.2	Basic operation in menu mode using the example of language selection	39
7.3	Setup	40
7.3.1	Overview	40
7.3.2	IP address and subnet mask	40
7.3.3	Unit	41
7.3.4	Temperature monitoring	42
7.3.5	Timer mode	43
7.3.6	Type of the slide-in unit (Grid or Shelf)	44
7.3.7	Balance	45
7.4	Date and Time	46
7.5	Calibration	48
7.6	Programme	50
7.7	Sound	51
7.8	Protocol	52
7.9	User ID	53
7.9.1	Description	53
7.9.2	User ID activation and deactivation	53
8.	Sterilisers SF^{PLUS}/SN^{PLUS}	54
8.1	Intended use	54
8.2	Note in accordance with Medical Devices Directive	54
8.3	Guidelines for sterilisation	54
9.	Maintenance and service	55
9.1	Cleaning	55
9.1.1	Working chamber and metal surfaces	55
9.1.2	Plastic parts	55
9.1.3	Glass surfaces	55
9.2	Regular maintenance	55
9.3	Repairs and service	55
10.	Storage and disposal	56
10.1	Storage	56
10.2	Disposal	56
Index		57

1. Safety regulations

1.1 Terms and signs used

In this manual and on the appliance itself, certain common terms and signs are used to warn you of possible dangers or to give you hints that are important in avoiding injury or damage. Observe and follow these hints and regulations to avoid accidents and damage. These terms and signs are explained below.

1.1.1 Terms used

"Warning" is used whenever you or somebody else could be injured if you do not observe the accompanying safety regulation.

"Caution" is used for information that is important for avoiding damage.

1.1.2 Signs used

Warning signs (warning of a danger)					
Danger of electrocution	Danger of explosion	Dangerous gases / vapours	Danger of burns	Danger of toppling over	Hazard area! Observe the operating instructions
Prohibition signs (forbidding an action)					
Do not lift	Do not tilt	Do not enter			
Regulation signs (stipulating an action)					
Disconnect the mains plug	Wear gloves	Wear safety boots	Observe information in separate manual		
Other icons					
	Important or useful additional information				

1.2 Product safety and dangers

The appliances described in this manual are technically sophisticated, manufactured using high-quality materials and subject to many hours of testing in the factory. They contain the latest technology and comply with recognised technical safety regulations. However, there are still risks involved, even when the appliances are used as intended. These are described below.



Warning!

After removing covers, live parts may be exposed. You may receive an electric shock if you touch these parts. Disconnect the mains plug before removing any covers. Only electrical technicians may work on the electrical equipment of the appliances.



Warning!

When loading the appliance with an unsuitable load, poisonous or explosive vapours or gases may be produced. This could cause the appliance to explode, and people could be severely injured or poisoned. The appliance may only be loaded with materials/test objects which do not form any toxic or explosive vapours when heated up (see also chapter "Intended use" on page 8).



Warning!

Depending on operation, the surfaces in the working chamber and the chamber load may still be very hot after the appliance is switched off. Touching these surfaces can cause burns. Wear heat-resistant protective gloves or wait until the appliance cools down. To do so, pull the handle bar until the door springs open into its ventilating position (see page 22).



Warning!

In case of appliances of a certain size, you can get accidentally locked in, which is life-threatening. Do not climb into the appliance!

1.3 Requirements of the operating personnel

The appliance may only be operated and maintained by persons who are of legal age and have been instructed accordingly. Personnel who are to be trained, instructed or who are undergoing general training may only work with the appliance under the continuous supervision of an experienced person.

Repairs may only be performed by qualified electricians. The regulations in the separate service manual must be observed.

1.4 Responsibility of the owner

The owner of the appliance

- ▶ is responsible for the flawless condition of the appliance and for its proper operation in accordance with its intended use (see page 8);
- ▶ is responsible for ensuring that persons who are to operate or service the appliance are qualified to do this, have been instructed accordingly and are familiar with the operating instructions at hand;
- ▶ must know about the applicable guidelines, requirements and operational safety regulations, and train staff accordingly;
- ▶ is responsible for ensuring that unauthorised persons have no access to the appliance;
- ▶ is responsible for ensuring that the maintenance plan is adhered to and that maintenance work is carried out properly (see page 55);
- ▶ has to ensure that the appliance and its surroundings are kept clean and tidy, for example through corresponding instructions and inspections;
- ▶ is responsible for ensuring that personal protective clothing is worn by operating personnel, e.g. work clothes, safety shoes and protective gloves.

1.5 Intended use

This appliance is exclusively intended for heating up non-explosive substances and objects. Any other use is improper, and may result in hazards and damage.

The appliance is not explosion-proof (does not comply with the German workplace health & safety regulation VBG 24). The appliance may only be loaded with materials and substances which cannot form any toxic or explosive vapours at the set temperature and which cannot explode, burst or ignite.

The appliance may not be used for drying, vaporising and branding paints or similar materials the solvents of which could form an explosive mixture when combined with air. If there is any doubt as to the composition of materials, they must not be loaded into the appliance. Potentially explosive gas-air mixtures must not form, neither in the working chamber nor in the direct vicinity of the appliance.

Intended use as a medical device

For appliances subject to the 93/42/EEC guideline (Council Directive on the approximation of the laws of the Member States relating to medical devices), the intended use is defined as follows:

- ▶ For appliances of the UF^{PLUS} type series: The appliance serves for heating non-sterile cloths and covers.
- ▶ For appliances of the IF^{PLUS} type series: The appliance serves for heating non-sterile cloths and covers, as well as for temperature control of rinsing and infusion solutions.
- ▶ For appliances of the IN^{PLUS} type series: The appliance serves for temperature control of rinsing and infusion solutions.
- ▶ For appliances of the SF^{PLUS} type series: The appliance serves for sterilising medical material through dry heated air at atmospheric pressure (also see page 54).

1.6 Changes and alterations

No unauthorised changes or alterations may be made to the appliance. No parts may be added or inserted which have not been approved by the manufacturer.

Unauthorised modifications or changes result in the CE declaration of conformity losing its validity and the appliance must no longer be operated.

The manufacturer is not liable for any damage, danger or injuries that result from unauthorised changes or alterations, or from non-observance of the regulations in this manual.

1.7 Behaviour in case of malfunctions and irregularities

The appliance may only be used in a flawless condition. If you as the operator notice irregularities, malfunctions or damage, immediately take the appliance out of service and inform your superior.

i You can find information on correcting malfunctions from page 35.

1.8 Switching off the appliance in an emergency

Push the On/Off switch on the control panel (Fig. 1) and disconnect power plug. This disconnects the appliance from the power supply at all poles.



Warning!
Depending on operation, the surfaces in the working chamber and the chamber load may still be very hot after the appliance is switched off. Touching these surfaces can cause burns. Wear heat-resistant protective gloves or wait until the appliance cools down. To do so, pull the handle bar until the door springs open into its ventilating position (see page 22).

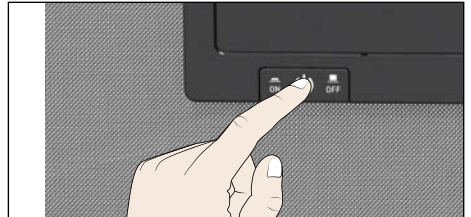

Fig. 1
Switch off the appliance by pressing the On/Off switch

2. Construction and description

2.1 Construction



Fig. 2 Construction

- | | |
|--|--------------------------------------|
| 1 ControlCOCKPIT with capacitive function keys (see page 24) | 5 Working chamber |
| 2 On/Off switch (see page 21) | 6 Nameplate (covered, see page 13) |
| 3 Working chamber fan (for UF/IF/SF appliances only) | 7 Door handle (see page 22) |
| 4 Steel grid | 8 Turn control with confirmation key |
| | 9 USB interface (see page 12) |

2.2 Function

Appliances of the UN^{PLUS}, SN^{PLUS} and IN^{PLUS} type series feature natural circulation (convection). For the UF^{PLUS}, SF^{PLUS} and IF^{PLUS} type series, air is circulated by a fan at the working chamber rear panel (Fig. 3, No. 1). It increases the air flow and provides stronger horizontal forced air circulation than natural convection.

In both the convection and fan ventilated appliances, supply air (2) is preheated in a pre-heating chamber (3). Through the ventilation slits in the side panel of the working chamber, the pre-heated air is introduced into the interior of the chamber. The supply and exhaust air (5) volume (air change) is controlled by the air flap (4) on the rear panel of the appliance.

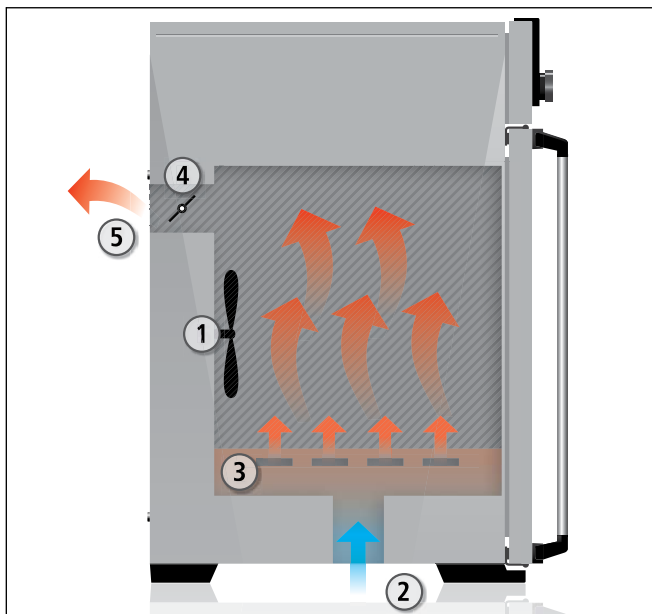

Fig. 3 Function

- 1 Fan
- 2 Fresh air
- 3 Pre-heating chamber
- 4 Air flap
- 5 Exhaust air

2.3 Material

For the outer housing, MEMMERT deploys stainless steel (Mat.No. 1.4016 – ASTM 430) and for the interior, stainless steel (Mat.No. 1.4301 – ASTM 304) is used, which stands out through its high stability, optimal hygienic properties and corrosion-resistance towards many (but not all!) chemical compounds (caution for example with chlorine compounds).

The chamber load for the appliance must be carefully checked for chemical compatibility with the materials mentioned. A material resistance table can be requested from the manufacturer.

2.4 Electrical equipment

- ▶ Operating voltage and current consumption: See nameplate
- ▶ Protection class I, i.e. operating insulation with PE conductor in accordance with EN 61010
- ▶ Protection type IP 20 acc. to EN 60 529
- ▶ Interference suppression acc. to EN 55011 class B
- ▶ Appliance fuse: Fusible link 250 V/15 A quick-blow
- ▶ The temperature controller is protected with a miniature fuse 100 mA (200 mA at 115 V)

2.5 Connections and interfaces

2.5.1 Electrical connection

This appliance is intended for operation on an electrical power system with a system impedance Z_{\max} of a maximum of 0.292 ohm at the point of transfer (service line). The operator must ensure that the appliance is operated only on an electrical power system that meets these requirements. If necessary, you can ask your local energy supply company what the system impedance is.

Observe the country-specific regulations when connecting (e.g. in Germany DIN VDE 0100 with residual current circuit breaker).

2.5.2 Communication interfaces

The interfaces are intended for appliances which meet the requirements of IEC 60950-1.

USB interface

The appliance is fitted by default with a USB interface in accordance with the USB specification. This way, you can

- ▶ transfer software stored on a USB storage medium to the appliance (see page 50).
- ▶ export protocol logs from the appliance to a USB storage medium (see page 52).
- ▶ transfer user ID data stored on a USB storage medium to the appliance (see page 53).

The USB interface is located on the lower right of the ControlCOCKPIT (Fig. 4).

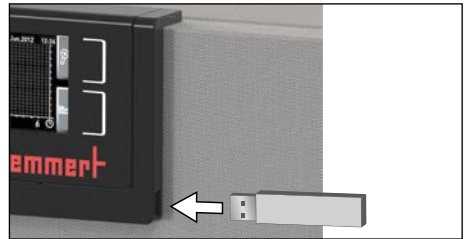

Fig. 4 USB interface

Ethernet interface

Via Ethernet interface, the appliance can be connected to a network, so that you can transfer programmes created with AtmoCONTROL software to the appliance and read out protocol logs. The Ethernet interface is located on the rear of the appliance (Fig. 5).

For identification purposes, each appliance connected must have its own unique IP address. Setting the IP address is described on page 40.

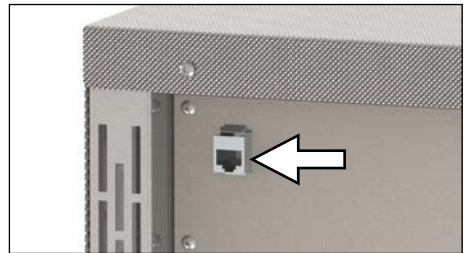

Fig. 5 Ethernet interface



You will find a description of how to transfer programmes via Ethernet in the enclosed AtmoCONTROL manual.

With an optional USB to Ethernet converter, the appliance can be directly connected to a computer / laptop (see Scope of delivery on page 16).

2.6 Designation (nameplate)

The nameplate (Fig. 6) provides information about the appliance model, manufacturer and technical data. It is attached to the front of the appliance, on the right side behind the door (see page 10).

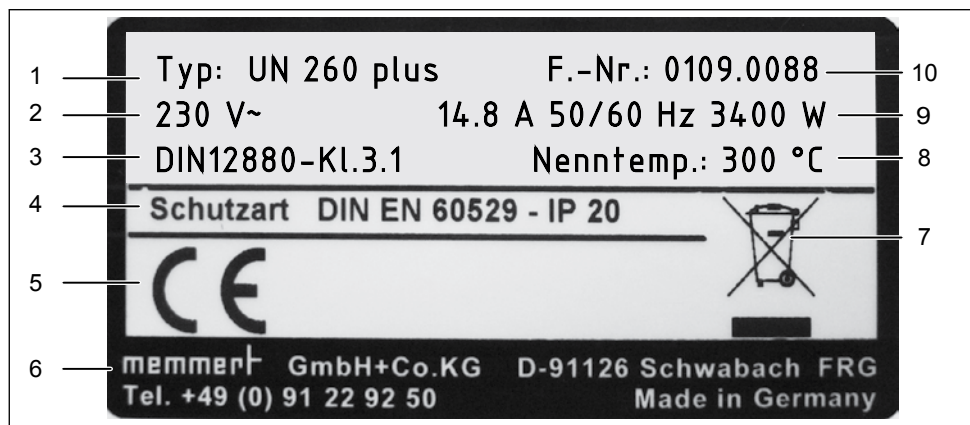

Fig. 6 Nameplate (example)

- | | | | |
|---|-------------------|----|----------------------------|
| 1 | Type designation | 6 | Address of manufacturer |
| 2 | Operating voltage | 7 | Disposal note |
| 3 | Applied standard | 8 | Temperature range |
| 4 | Protection type | 9 | Connection / power ratings |
| 5 | CE conformity | 10 | Appliance number |

2.7 Technical data

Appliance size	30	55	75	110	160	260	450	750	
Appliance width D ¹ [mm]	585	585	585	745	745	824	1224	1224	
Appliance height E ¹ [mm]	707	787	947	867	1107	1186	1247	1726	
Appliance depth G ¹ (footprint) [mm]	434	514	514	584	584	684	784	784	
Depth of door lock [mm]	56								
Appliance depth F ¹ (including door handle) [mm]	490	570	570	640	640	740	840	840	
Working chamber width A ¹ [mm]	400	400	400	560	560	640	1040	1040	
Working chamber height B ¹ [mm]	320	400	560	480	720	800	720	1200	
Working chamber depth C ¹ [mm]	250	330	330	400	400	500	600	600	
Chamber volume [litres]	32	53	74	108	161	256	449	749	
Weight [kg]	48	57	66	78	96	110	170	217	
Power [W]	IN/IF	115 V, 50/60 Hz	1600	850	1100	1100	1100	1500	1800
		230 V, 50/60 Hz	1600	1000	1250	1400	1600	1700	1800
	UN/UF/SN/SF	230 V, 50/60 Hz	1600	2000	2500	2800	3200	3400	-
		115 V, 50/60 Hz	1600	1700	2200	2200	2200	2200	-
Current consumption [A]	IN/IF	400 V, 50/60 Hz	-	-	-	-	5800 ²	7000 ²	
		230 V, 50/60 Hz	7,0	4,3	5,4	6,1	7,0	7,4	8,7
	UN/UF/SN/SF	115 V, 50/60 Hz	13,9	7,4	9,6	9,6	9,6	13,0	15,7
		230 V, 50/60 Hz	7,0	8,7	10,9	12,2	13,9	14,8	-
max. number of sliding shelves	UN/UF/SN/SF	115 V, 50/60 Hz	13,9	14,8	19,1	19,1	19,1	-	
		400 V, 50/60 Hz	3	4	6	5	8	9	14
max. load per sliding shelves [kg]	30								
max. load per appliance [kg]	60	80	120	175	210	210	300	300	
Setting temperature range	IN/IF	+20 to +80 °C ³							
Adjustment precision	UN/UF	+20 to +300 °C ³							
	SN/SF	+20 to +250 °C ³							
Setting temperature range	IN/IF	0.1 K							
	UN/UF/SN/SF	up to 100 °C: 0.1 K, above 100 °C: 0.5 K							

¹ See Fig. 7 on page 15

² 3 x 230 V without zero

³ With the interior lighting on, the minimum temperature might not be reached.

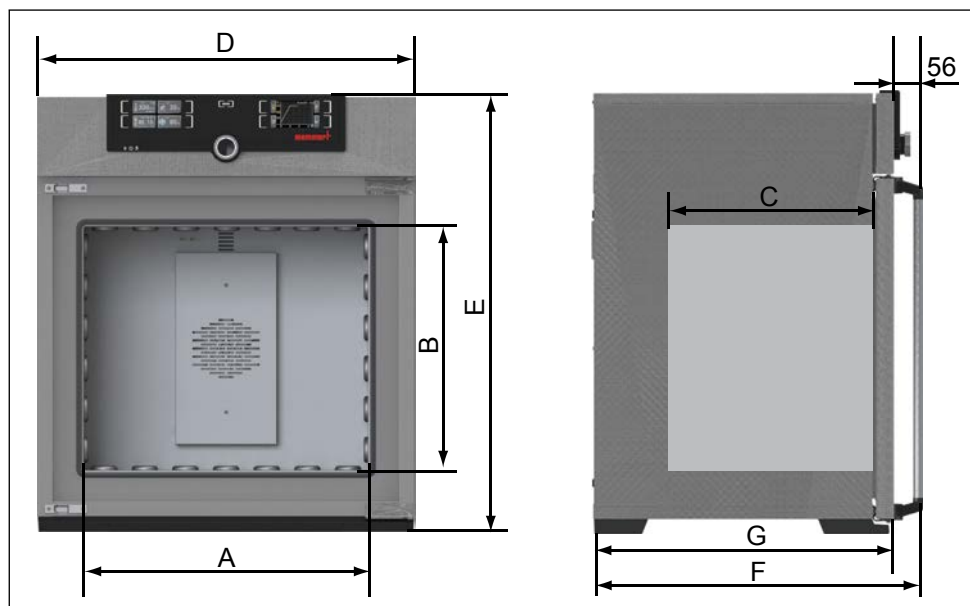

Fig. 7 Dimensions (see table on page 14)

2.8 Applied directives and standards

- ▶ Directive 2004/108/EC amended (Directive of the council on harmonisation of the laws of the member states on electromagnetic compatibility). Fulfilled standards:
DIN EN 61326:2004-05, EN 61326:1997, EN 61326/A1:1998, EN 61326/A2:2001
EN 61326/A2:2003
- ▶ Directive 2006/95/EC amended (Directive of the council on harmonisation of the laws of member states relating to electrical equipment designed for use within certain voltage limits). Standards complied with:
DIN EN 61 010-1 (VDE 0411 Part 1):2002-08
DIN EN 61 010-2-010 (VDE 0411 Part 2-010):2004-06
EN 61 010-1:2001, EN 61 010-2-010:2003

When used as a medical device

- ▶ Directive 93/42/EEC (Directive of the Commission on the harmonisation of the legal regulations of the member states on medical devices)
- ▶ Directive 2004/108/EC amended (Directive of the council on harmonisation of the laws of the member states on electromagnetic compatibility). Standards complied with:
DIN EN 61326:2004-05, EN 61326:1997, EN 61326/A1:1998, EN 61326/A2:2001
EN 61326/A2:2003

2.9 Declaration of conformity

You can download the EC declaration of conformity of the appliance online:

English: <http://www.memmert.com/en/service/downloads/ce-statement/>

German: <http://www.memmert.com/de/service/downloads/eg-konformitaetserklaerung/>

2.10 Ambient conditions

- ▶ The appliance may only be used in enclosed rooms and under the following ambient conditions:

Ambient temperature	+5 °C to +40 °C
Humidity rh	max. 80 %, non-condensing
Overvoltage category	II
Pollution degree	2
Altitude of installation	max. 2,000 m above sea level

- ▶ The appliance may not be used in areas where there is a risk of explosion. The ambient air must not contain any explosive dusts, gases, vapours or gas-air mixtures. The appliance is not explosion-proof.
- ▶ Heavy dust production or aggressive vapours in the vicinity of the appliance could lead to sedimentation in the interior and, as a consequence, could result in short circuits or damage to electrical parts. For this reason, sufficient measures to prevent large clouds of dust or aggressive vapours from developing should be taken.

2.11 Scope of delivery

- ▶ Power cable
- ▶ Tilt protection
- ▶ One or two sliding steel grids (load capacity 30 kg each)
- ▶ USB storage medium with software and AtmoCONTROL manual
- ▶ The operating instructions at hand
- ▶ Calibration certificate

2.12 Optional accessories

- ▶ USB to Ethernet converter (Fig. 8). Makes it possible to connect the appliance's network interface (see page 12) to the USB port of a computer / laptop.
- ▶ Reinforced, sliding steel grids with a load capacity of 60 kg each (for appliance size 110 and larger)

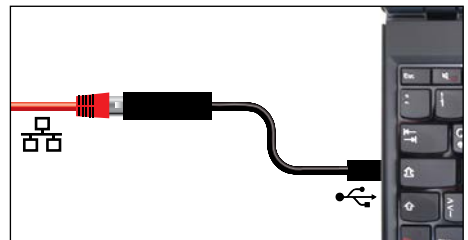

Fig. 8 Converter USB to Ethernet

3. Delivery, transport and setting up

3.1 Safety regulations



Warning!

You may get your hands or feet squashed when transporting and installing the appliance. Wear protective gloves and safety boots.



Warning!

Because of the heavy weight of the appliance, you could injure yourself if you try to lift it. To carry appliances of the sizes 30 and 55, at least two persons, for appliances of the sizes 75 and 110, four people are needed. Appliances larger than that may not be carried but must be transported with a manual pallet jack or forklift truck.

30	55	75	110	160	260	450	750



Warning!

The appliance could fall over and seriously injure you. Never tilt the appliance and transport it in upright position and without load only (except for standard accessories such as steel grids or shelves).

3.2 Delivery

The appliance is packed in cardboard and is delivered on a wooden pallette.

3.3 Transport

The appliance can be transported in three ways:

- ▶ With a forklift truck; move the forks of the truck entirely under the pallet
- ▶ On a manual pallet jack
- ▶ On its own castors, in case of the corresponding configuration, for which the catch on the (front) castors must be released

3.4 Unpacking

i To avoid damage, do not unpack the appliance until you reach the installation site.

Remove the cardboard packaging by pulling it upwards or carefully cutting along an edge.

3.4.1 Checking for completeness and transport damage

- ▶ Check the delivery note to ensure that the delivery is complete.
- ▶ Check the appliance for damage.

If you notice deviations from the delivery note, damage or irregularities, do not put the appliance into operation but inform the haulage company and the manufacturer.

3.4.2 Disposing of packaging material

Dispose of the packaging material (cardboard, wood, foil) in accordance with the applicable disposal regulations for the respective material in your country.

3.5 Storage after delivery

If the appliance is first to be stored after delivery: Read the storage conditions from page 56.

3.6 Setting up



Warning!

Due to its centre of gravity, the appliance can fall over to the front and injure you or other people. Always attach the appliance to a wall with the tilt protection (see page 20). If this cannot be done due to space problems, do not operate the appliance and do not open the door. Contact the Memmert service team (see page 2).

3.6.1 Prerequisites

The installation site must be flat and horizontal and must be able to reliably bear the weight of the appliance (see "Technical data" on page 14). Do not place the appliance on a flammable surface.

Depending on the model (see nameplate), a 230 V, 115 V or 400 V power connection must be available at the installation site.

The distance between the wall and the rear of the appliance must be at least 15 cm. The clearance from the ceiling must not be less than 20 cm and the side clearance from walls or nearby appliances must not be less than 5 cm (Fig. 9). Sufficient air circulation in the vicinity of the appliance must be guaranteed at all times.

For appliances with castors, these need to be positioned in forward direction at all times.

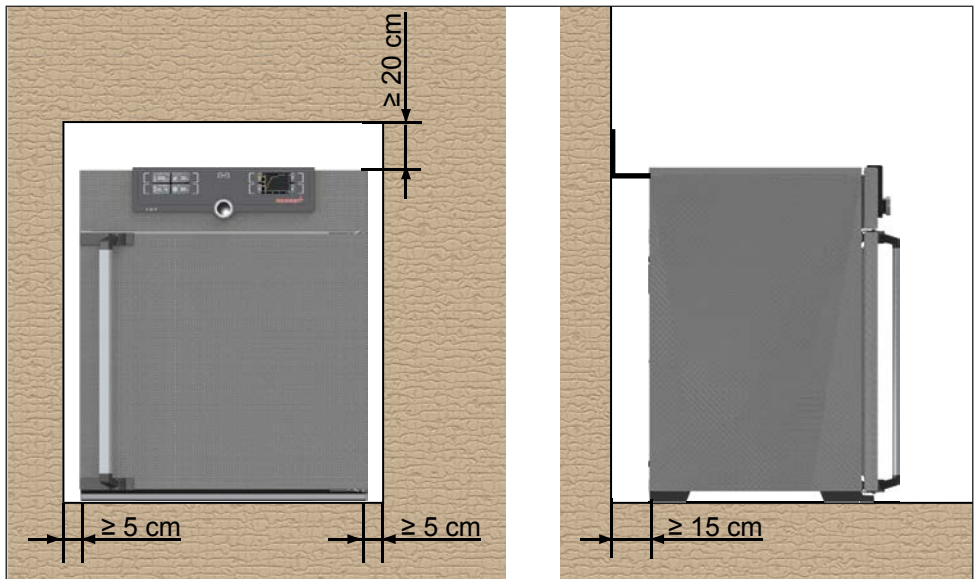









Fig. 9 Minimum clearance from walls and ceiling

3.6.2 Installation options

Setting up	Comments	Suitable for appliance size ...							
		30	55	75	110	160	260	450	750
Floor 		✓	✓	✓	✓	✓	✓	✓	✓
Table 	Check the load capacity first	✓	✓	✓	✓	✗	✗	✗	✗
Stacked 	two appliances maximum; mounting material (feet) provided	✓	✓	✓	✓	✗	✗	✗	✗
Wall mounting 	Separately packaged fastening material is included in the scope of delivery. Observe the assembly instructions provided.	✓	✓	✓	✓	✓	✗	✗	✗
Base 	with/without castors	✓	✓	✓	✓	✓	✓	✓	✗
Castor frame 		✓	✓	✓	✓	✓	✓	✗	✗
Height adjustable feet 		✓	✓	✓	✓	✓	✓	✓	✓

3.6.3 Tilt protection

Attach the appliance to a wall with the tilt protection. The tilt protection is included in the delivery.

1. As illustrated, fasten the tilt protection to the rear side of the appliance.

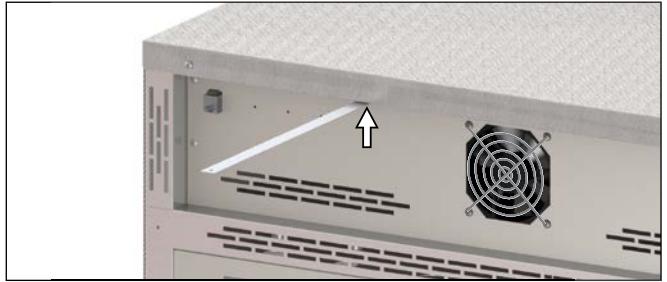

2. Bend the tilt protection upwards by 90 ° in the desired distance to the wall (consider the minimum distance to the wall, see Fig. 9).



3. Drill a hole, insert a plug and screw the tilt protection to a suitable wall.

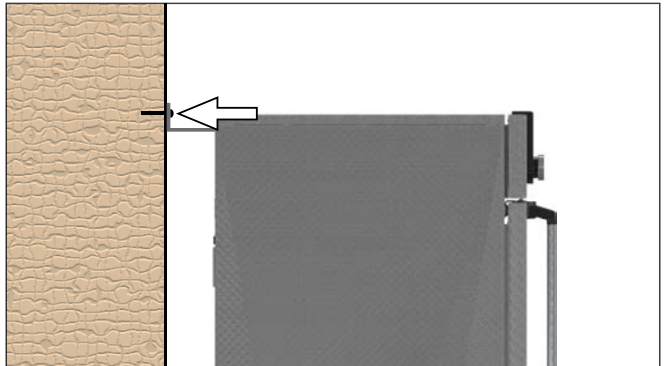

4. Putting into operation

● Caution:

1 The first time the appliance is operated, it must not be left unattended until it has reached the steady state.

4.1 Connecting the appliance

● Caution:

1 Observe the country-specific regulations when making connections (e.g. in Germany DIN VDE 0100 with residual current circuit breaker). Observe the connection and power ratings (see nameplate and "Technical data" on page 14). Make sure to establish a safe PE conductor connection. Place the power cable where it is easily accessible at all times and can be pulled off quickly, for example in case of an interference or emergency.

230/115-V appliances:

Plug the provided power cable into the rear of the appliance and connect it to a CEE 7/4 socket (Fig. 10).

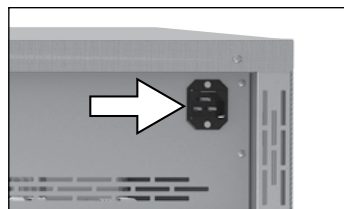

Fig. 10 Power connection
230/115 V

400V appliances:

The power cable is permanently installed. Connect the plug to a 400 V CEE coupling (Fig. 11).



Fig. 11 400 V CEE connection

4.2 Switching on

Switch on the appliance by pressing the On/Off switch on the front of the appliance (Fig. 12).

● After the first start-up, the appliance display is set to

1 English by default. You can change the language as described from page 39. However, to get a basic overview of operating the appliance, you should read the following chapter first.

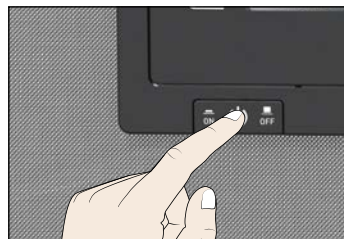

Fig. 12 Switch on appliance

5. Operation and control

Caution:

1 When loading and operating sterilisers of the SN^{PLUS}/SF^{PLUS} type, make sure to observe the special notes provided in chapter “Sterilisers SFPLUS/SNPLUS” from page 54.

5.1 Operating personnel

The appliance may only be operated by persons who are of legal age and have been instructed accordingly. Personnel who are to be trained, instructed or who are undergoing general training may only work with the appliance under the continuous supervision of an experienced person.

5.2 Opening the door

- ▶ To open the door, pull the handle bar to the side (to the left or to the right, depending on the door variation, see Fig. 13, A). The door opens slightly, so that the heat can be vented with the door ajar in case of high temperature inside the chamber. The door can then be opened completely (B).
- ▶ To close the door, push the handle bar back (C).

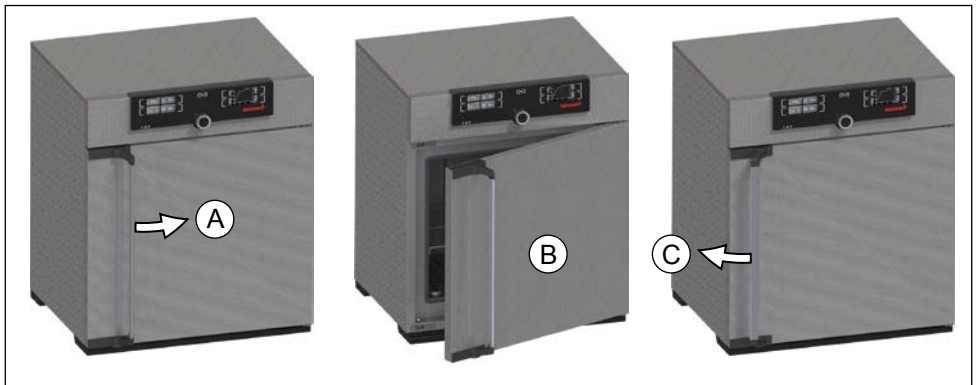

Fig. 13 Opening and closing the door



Warning!

In case of appliances of a certain size, you can get accidentally locked in, which is life-threatening. Do not climb into the appliance!

5.3 Loading the appliance



Warning!

When loading the appliance with an unsuitable load, poisonous or explosive vapours or gases may be produced. This could cause the appliance to explode, and persons could be severely injured or poisoned. The appliance may only be loaded with materials which do not form any toxic or explosive vapours when heated up and cannot ignite (see also "Intended use" on page 8). If there is any doubt as to the composition of materials, they must not be loaded into the appliance.



Caution:

Check the chamber load for chemical compatibility with the materials of the appliance (see page 11).

Insert the sliding steel grids or sliding shelves. The maximum number of grids / shelves and the load capacity are specified in the technical data overview from page 14.

The chamber must not be loaded too tightly, so that proper air circulation in the working chamber is guaranteed. Do not place any chamber load on the floor, touching the side walls or right below the ceiling of the working chamber (Fig. 14, see also the "correct loading" sticker on the appliance).

In case of improper loading (chamber loaded too tightly), the set temperature may be exceeded or it may take longer until it is reached.

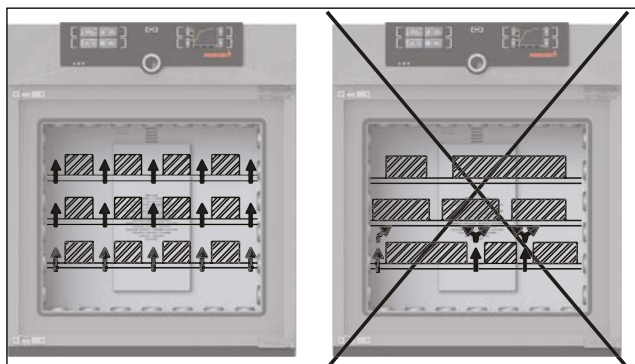

Fig. 14 Correct placement of the chamber load

To achieve the correct heating capacity, the type of slide-in unit used – Grid or Shelf – must be set in the menu under **SETUP** (see page 44).

5.4 Operating the appliance

5.4.1 ControlCOCKPIT

In manual operation, the desired parameters are entered at the ControlCOCKPIT on the front of the appliance (Fig. 15 and Fig. 16). You can also make basic settings here (menu). Additionally, warning messages are displayed, e.g. if the temperature is exceeded. In programme mode, the parameters defined, the programme description, the programme segment currently active and programme duration remaining are displayed (for a more detailed description, see page 28).

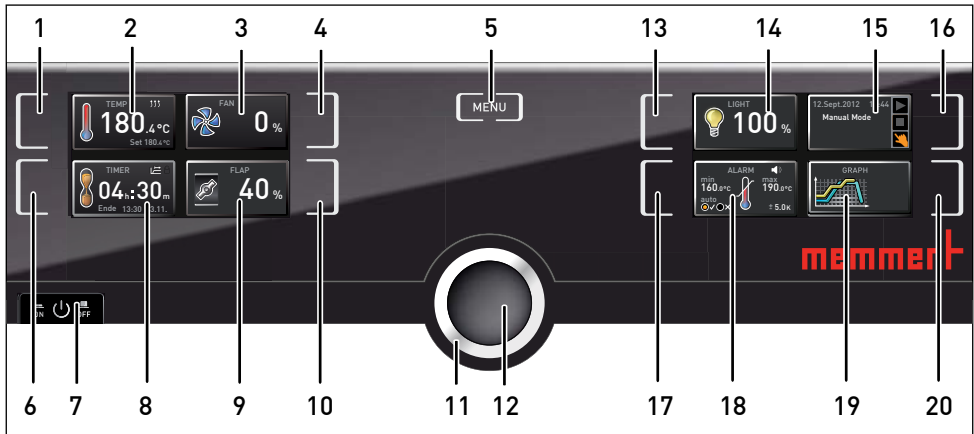

Fig. 15 ControlCOCKPIT for UFPLUS/IFPLUS/SFPLUS appliances in operating mode (width may differ depending on appliance size)

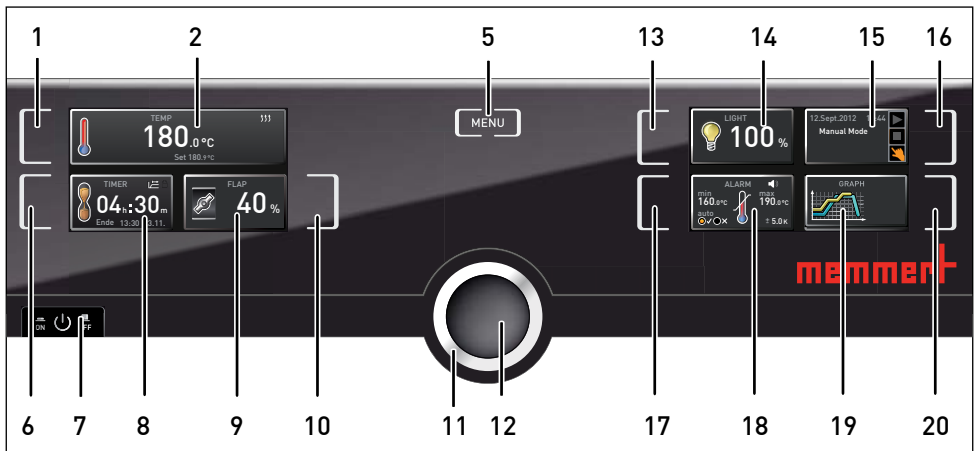

Fig. 16 ControlCOCKPIT for UNPLUS/INPLUS/SNPLUS appliances in operating mode (width may differ depending on appliance size)

- | | |
|---|--|
| <ul style="list-style-type: none"> 1 Activation key for temperature setpoint adjustment 2 Setpoint and actual temperature display 3 Fan speed display 4 Activation key for fan speed setting 5 Switch to menu mode (see page 38) 6 Activation key for timer setting 7 On/Off switch 8 Timer display 9 Air flap position display 10 Activation key for air flap position adjustment 11 Turn control for setpoint adjustment | <ul style="list-style-type: none"> 12 Confirmation key (accepts setting made with the turn control) 13 Activation key for interior lighting (additional option) 14 Interior lighting display (additional option) 15 Appliance state and programme display 16 Activation key for the appliance state 17 Activation key for temperature monitoring 18 Temperature monitoring display 19 Graphic representation 20 Activation key for graphic representation |
|---|--|

5.4.2 Basic operation

In general, all settings are made according to the following pattern:

1. Activate the desired parameter (e.g. temperature). To do so, press the corresponding activation key on the left or right or the respective display. The activated display is lined in colour, the other displays are dimmed. The set value is highlighted in colour.

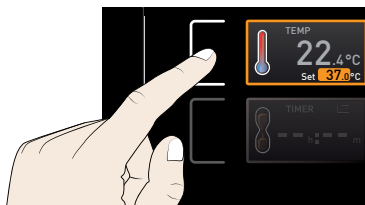

2. By turning the turn control to the left or right, adjust the set value (e.g. to 180.0 °C).

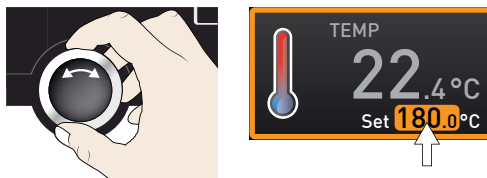

3. Save the set value by pressing the confirmation key. The display returns to normal and the appliance begins adjusting to the defined set value.

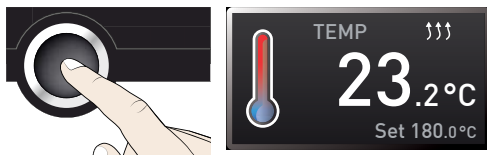

Additional parameters (air flap position etc.) can be set accordingly.

- 1 If no new values are entered or confirmed for approx. 30 seconds, the appliance automatically returns to the main menu and restores the former values.

If you want to cancel the setting procedure, press the activation key on the left or right of the display that you want to exit. The appliance restores the former values. Only the settings that you have confirmed by pressing the confirmation key before cancelling the setting procedure are accepted.

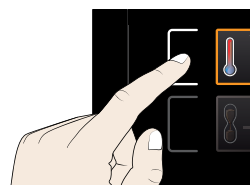



5.4.3 Operating modes

The appliance can be operated in three modes:

- ▶ **Manual mode:** The appliance runs in permanent operation at the values set on the ControlCOCKPIT. Operation in this mode is described in chapter 5.4.4.
- ▶ **Timer operation:** The appliance runs at the values set until the timer has elapsed. Operation in this mode is described in chapter 5.4.5.
- ▶ **Programme mode:** The appliance automatically runs programme sequences which have been defined using AtmoCONTROL software at a computer / laptop and then transferred to the appliance from a USB stick or via Ethernet. Operation in this mode is described in chapter 5.4.6.

i The status display shows you which operating mode or operating state the appliance is currently in. The current operating state is highlighted in colour and indicated by the text display:

-  Appliance is in programme mode
-  Programme is stopped
-  Appliance is in manual operating mode

The example on the right shows the appliance in manual mode, identified by the coloured hand symbol.

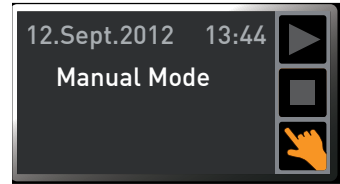

5.4.4 Manual mode

In this operating mode, the appliance runs in permanent operation at the values set on the ControlCOCKPIT.

Adjustment options

As described in chapter 5.4.2, you can set the following parameters after pressing the corresponding activation key (in any sequence):

Temperature

Adjustment range: model dependent (see nameplate and technical date on page 14)

i Heating operation is indicated by the $\uparrow\uparrow\uparrow$ symbol.

i You can select °C or °F as the temperature unit displayed (see page 41).

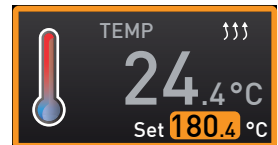

Air flap position

Adjustment range: 0 % (closed, recirculating operation) to 100 % (completely opened, fresh air operation) in steps of 10 %

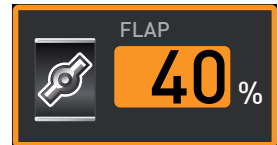

Fan speed

(only for UF/IF/SFPLUS appliances)

Adjustment range: 0 to 100 % in steps of 10%

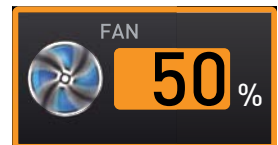

Interior lighting (additional option)

Adjustment range: 0 %, 100 %



5.4.5 Timer operation

In timer operation, you can adjust the time the appliance runs at the set value:

1. Press the activation key to the left of the timer display. The timer display is activated.

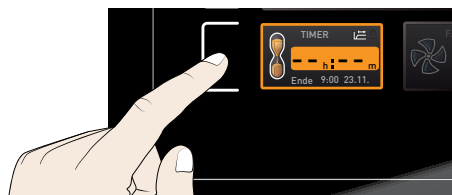

2. Turn the turn control until the desired duration is displayed – in this example 4 hours 30 minutes. The approximate end time is shown beneath, in a smaller font.



- Up to a duration of 23 hours 59 minutes, the time is displayed in hh:mm (hours:minutes) format. For 24 hours and more, the format dd:hh (days:hours) is used. The maximum duration adjustable is 99 days 00 hours.

3. Press the confirmation key to confirm.

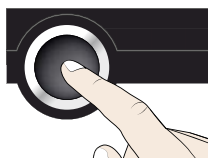

The display now shows the remaining time in a large font and the approximate end time in a smaller font beneath. The status display shows „Timer active“.



4. Now, as described under 5.4.2, set the individual values for temperature, air flap position etc. which you want the appliance to operate at. For universal ovens UN^{PLUS}/UF^{PLUS} and incubators IN^{PLUS}/IF^{PLUS}, the set values can be changed while the timer elapses. The changes are effective immediately. For sterilisers SN^{PLUS}/SF^{PLUS}, parameters cannot be changed while the timer elapses.

- For universal ovens UN^{PLUS}/UF^{PLUS} and incubators IN^{PLUS}/IF^{PLUS}, you can choose if the timer should run setpoint-dependent or not in the **Setup** – this determines if the timer should not start until a tolerance band around the set temperature is reached or if it should start right after activation (see page 43). If the timer runs setpoint-dependent, this is indicated by the  symbol in the timer display.

When the timer has elapsed, the display shows 00h:00m. All functions (heating etc.) are switched off. If a fan had been active, it will keep on running for a short safety period. In addition, an acoustic alarm sounds, which can be turned off by pressing the confirmation key.

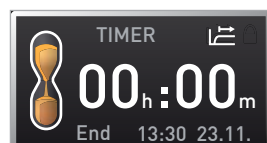

To deactivate the timer, open the timer display by pressing the activation key again and then turning the turn control to reduce the timer setting until --:-- is displayed. Confirm with the confirmation key.

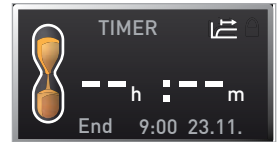

5.4.6 Programme mode

In this operating mode, programmes saved in the appliance can be started with different combinations of individual parameters (temperature, air flap position, fan speed, working chamber lighting) at staggered intervals, which the appliance then automatically processes in sequence. These programmes are not created directly at the appliance but externally at a computer / laptop and using AtmoCONTROL software. Transfer to the appliance is possible using the provided USB storage medium or via Ethernet.



A description of how to create and save programmes can be found in the separate AtmoCONTROL software manual.

Starting a programme

1. Press the activation key to the right of the status display. The current operating mode is highlighted automatically, in this example **Manual Mode** (👉).



2. Turn the turn control until the ▶ start symbol is highlighted. The current programme is displayed, in this example **Test 012**.

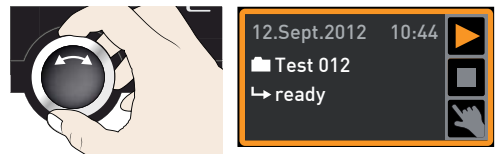

1 Only the programme currently selected in the menu and shown in the display can be used. If you want to process another programme, you need to activate it in the menu first (description from page 48).

3. To start the programme, press the confirmation key. The programme starts. The display shows:

- ▶ the programme description (in this example **Test 012**)
- ▶ the programme segment description, in this example **Ramp 1**
- ▶ the current run (in case of loops)

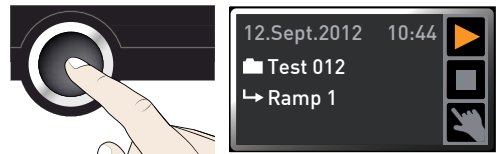



1 You cannot change any parameters (e.g. the temperature) at the appliance while a programme is running. However, the displays **ALARM** and **GRAPH** can still be used.

Canceling a programme

You can cancel an active programme at any time.

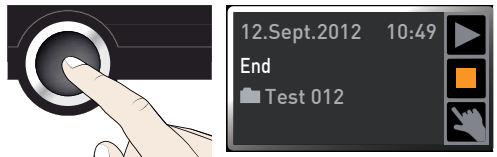
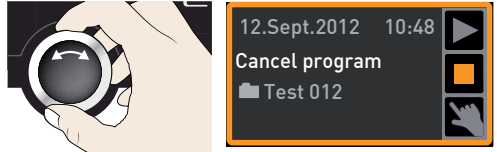
1. Press the activation key to the right of the status display. The status display is automatically highlighted.
2. Turn the turn control until the stop symbol  is highlighted.
3. Press the confirmation key to confirm. The programme is cancelled.



 A cancelled programme cannot be resumed at the point it was cancelled. It must be restarted from the beginning.

End of programme

The display shows **End** when the programme is finished.

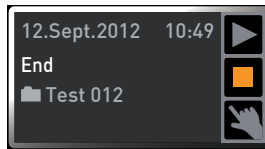

You can now

- ▶ restart the programme as described
- ▶ select another programme for processing in menu mode (see page 50) and run it as described.
- ▶ return to manual mode. To do so, reactivate it by pressing the activation key next to the status display, then turn the turn control until the hand symbol  is highlighted in colour and press the confirmation key.

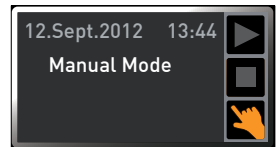



5.5 Temperature monitoring

The appliance is equipped with a multiple overtemperature protection (mechanical/electronic) in accordance with DIN 12 880. This serves to avoid damage to the chamber load and/or appliance in case of a malfunction:

- ▶ electronic temperature monitoring (TWW)
- ▶ automatic temperature monitor (ASF)
- ▶ mechanical temperature limiter (TB)

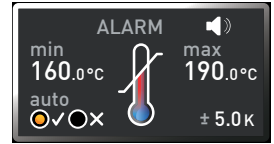
The monitoring temperature of the electronic temperature monitoring is measured via a separate Pt100 temperature sensor in the working chamber. Temperature monitoring settings are made via the **ALARM** display. The settings made apply to all operating modes.



If temperature monitoring has been triggered, this is indicated by the temperature display: the actual temperature is highlighted in red and a warning symbol  is shown (Fig. 17). The type of temperature monitoring triggered (TWW in this example) is shown beneath the temperature. If the acoustic alarm has been activated in the menu mode (Sound, see page 51, indicated by the speaker symbol in the alarm display), the alarm is additionally signalled by an intermittent acoustic signal, which can be turned off by pressing the confirmation key. Information on what to do in this case are provided in the chapter "Malfunctions, warning and error messages" from page 35.

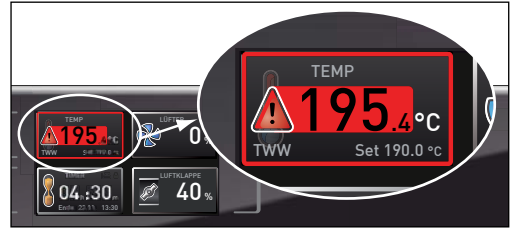

Fig. 17 Temperature monitoring triggered

Before reading how to adjust temperature monitoring (from page 32), please read the description of the individual monitoring functions here.

5.5.1 Electronic temperature monitoring (TWW)

The manually set monitoring temperature **min** and **max** of the electronic overtemperature control is monitored by an adjustable over/undertemperature controller (TWW) protection class 3.1 acc. to DIN 12 880 (or over/undertemperature controller (TWW) protection class 3.1 for UIS appliances). If the manually set monitoring temperature **max** is exceeded, the TWW takes over temperature control and begins to regulate the monitoring temperature (Fig. 18).

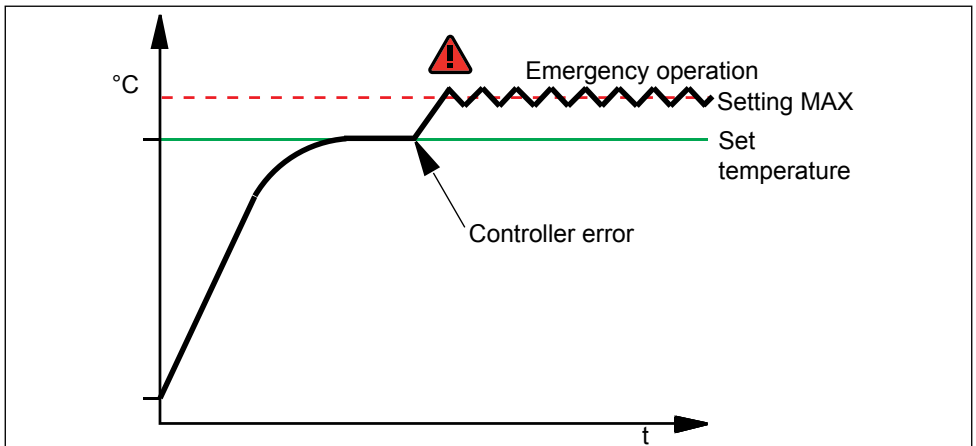

Fig. 18 Schematic diagram of how the TWW temperature monitoring works

5.5.2 Electronic temperature limiter (TWB) protection class 2 acc. to DIN 12 880
If the manually set monitoring temperature **max** is exceeded, the TWB switches off heating permanently (Fig. 19) and can be reset by pressing the confirmation key.

i In programme mode, the current programme is resumed for TWB alarms of up to 15 minutes. If the alarm is active for more than 15 minutes, the programme is cancelled.

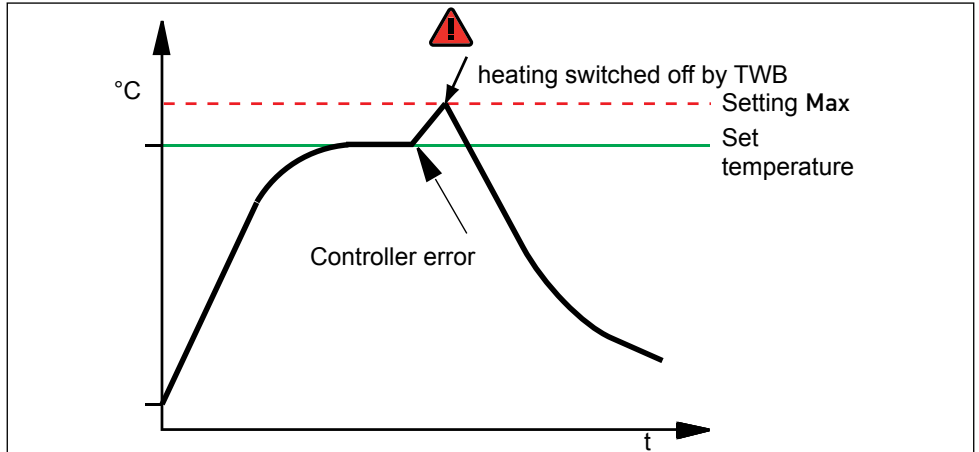

Fig. 19 Schematic diagram of how the TWB temperature monitoring works

5.5.3 Automatic temperature monitor (ASF)

ASF is a monitoring device that automatically follows the set temperature setpoint within an adjustable tolerance band (Fig. 20).

The ASF – if switched on – is automatically activated as soon as the actual temperature value reaches 50 % of the set tolerance band of the setpoint (in the example: 180 °C – 1.5 K) for the first time (section A).

When the temperature violates the set tolerance band around the setpoint (in the example in Fig. 20:

180 °C ± 3 K) – e.g. if the door is opened during operation (section B of illustration) – the alarm is set off. The ASF alarm is automatically triggered as soon as 50 % of the set tolerance band of the setpoint (in the example: 180 °C ± 1.5 K) are reached again (section C).

If the temperature setpoint is altered, the ASF is automatically disabled temporarily (in this example: The setpoint is changed from 180 °C to 173 °C, section D) until the tolerance range of the new temperature setpoint is reached again (section E).

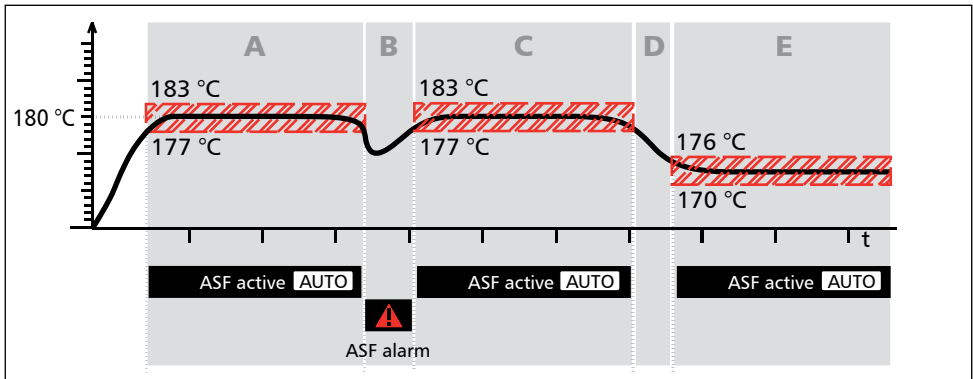

Fig. 20 Schematic diagram of how the ASF temperature monitoring works

5.5.4 Mechanical temperature monitoring: Temperature limiter (TB)

The appliance is equipped with a mechanical temperature limiter (TB) of protection class 1 in accordance with DIN 12 880.

If the electronic monitoring unit should fail during operation and the factory-set maximum temperature is exceeded by approx. 20 °C, the temperature limiter, as the final protective measure, switches off the heating permanently.

5.5.5 Adjusting temperature monitoring

1. Press the activation key to the left of the **ALARM** display. The min setting (under-temperature protection) is automatically activated.

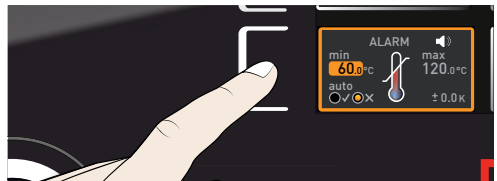

- By turning the turn control, adjust the desired lower alarm limit value, in the example on the right 160 °C.

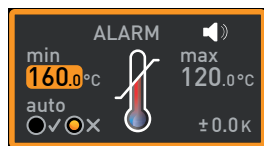

- If no undertemperature protection limit is required, set the lowest temperature.

- Press the confirmation key to confirm. The max display (overtemperature protection) is activated.

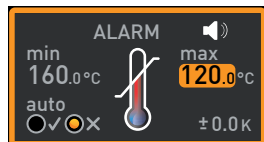
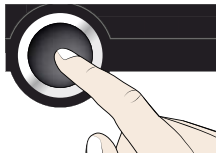

- By turning the turn control, adjust the desired upper alarm limit value, in the example on the right 190 °C.

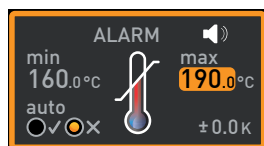

- The monitoring temperature must be set sufficiently high above the maximum set temperature. We recommend 5 to 10 K.

- Accept the upper alarm limit value by pressing the confirmation key. The setting of the automatic temperature monitor (ASF) is automatically activated (auto).

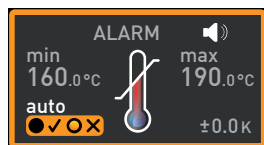
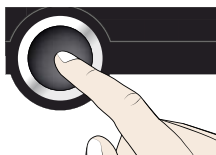

- With the turn control, select ON (✓) or OFF (✗).

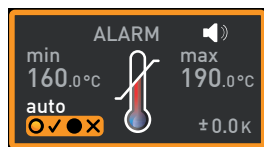

- Press the confirmation key to confirm. The ASF tolerance band setting is activated.

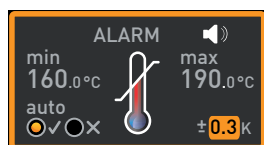
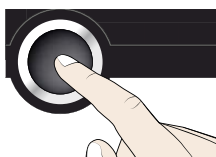

- With the turn control, adjust the desired tolerance band, e.g. 5.0 K.

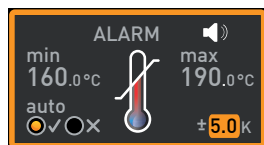

- We recommend a tolerance band of 5 to 10 K (1 to 3 K for incubators IN/IF).

- Press the confirmation key to confirm. Temperature monitoring is now active.

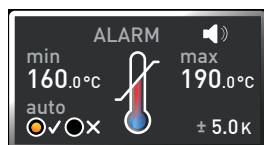
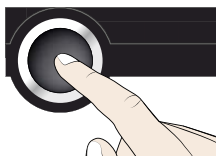

Operation and control

In the menu, you can set:

- ▶ which type of protection (TWW or TWB) should be active (see page 42)
- ▶ if an acoustic signal should be triggered on alarm (see page 51)

5.6 Graph

The GRAPH display provides an overview of the chronological sequence of the set values and the actual values as a curve.

1. Press the activation key to the right of the GRAPH display. The display is enlarged and the temperature profile shown.

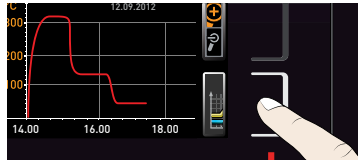

- ▶ To change the time frame to be displayed: Press the activation key next to the $\triangleleft \triangleright$ arrow symbols. The time frame to be displayed can now be changed by turning the turn control.

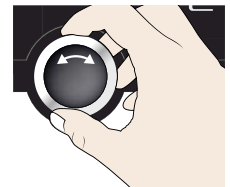
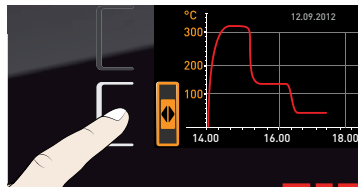

- ▶ To extend or reduce the time frame to be displayed: Press the activation key next to the magnifying glass symbol. With the turn control, select if you want to zoom in or out (+/-) and confirm your selection by pressing the confirmation key.

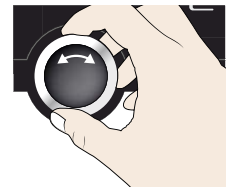
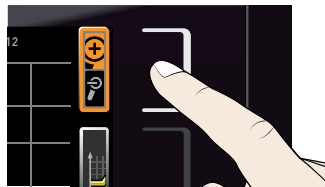

To close the graphical representation, again press the activation key which you have used to activate it.

5.7 Ending operation



Warning!

Depending on the operation performed, the surfaces in the working chamber and the chamber load may still be very hot after the appliance is switched off. Touching these surfaces can cause burns. Wear heat-resistant protective gloves or wait until the appliance cools down. To do so, pull the handle bar until the door springs open into its ventilating position (see page 22).



1. Switch off active appliance functions (turn back the set values).
2. Remove the chamber load.
3. Switch off the appliance (Fig. 21).



Fig. 21 Switch off appliance

6. Malfunctions, warning and error messages



Warning!

After removing covers, live parts may be exposed. You may receive an electric shock if you touch these parts. Malfunctions requiring work inside the appliance may only be rectified by electricians. Observe the separate service manual for this.

Do not try to rectify appliance errors yourself but contact the MEMMERT customer service department (see page 2) or an authorised service point.

In case of enquiries, please always specify the model and appliance number from the nameplate (see page 13).

6.1 Warning messages of the monitoring function

i If the acoustic alarm has been activated in the **Signals** menu (see page 51), which is indicated by the speaker symbol  in the alarm display, the alarm is additionally signalled by an intermittent acoustic signal. If the confirmation key is pressed, the acoustic alarm can be temporarily switched off until the next alarm event occurs.

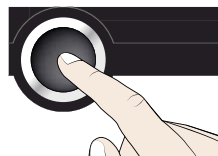

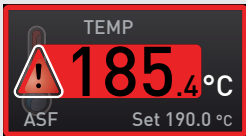
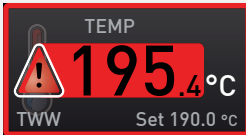

6.1.1 Temperature monitoring

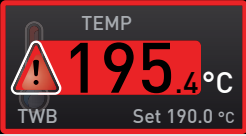
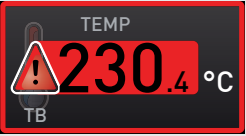
Description	Cause	Action	See
Temperature alarm and "ASF" are displayed 	Automatic temperature monitor (ASF) triggered	Check if the door is closed. Close the door. Extend the ASF tolerance band If the alarm continues: Contact customer service	page 33 page 2
Temperature alarm and "TWW" are displayed 	The adjustable undertemperature / overtemperature controller (TWW) has assumed heating control.	Increase the difference between the monitoring and setpoint temperature – by either increasing the max value of the temperature monitoring or decreasing the setpoint temperature. If the alarm continues: Contact customer service	page 32 page 2

Description	Cause	Action	See
Temperature alarm and "TWB" are displayed 	The electronic temperature limiter (TWB) permanently switched off heating.	Deactivate the alarm by pressing the confirmation key. Increase the difference between the monitoring and setpoint temperature – by either increasing the max value of the temperature monitoring or decreasing the setpoint temperature. If the alarm continues: Contact customer service	page 32 page 2
Temperature alarm and "TB" are displayed 	The mechanical temperature limiter (TB) permanently switched off heating.	Switch off the appliance and leave to cool down. Contact customer service and have the error rectified (e.g. by replacing the temperature sensor).	page 2

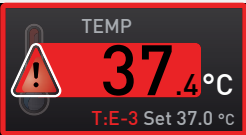
6.2 Malfunctions, operating problems and appliance errors

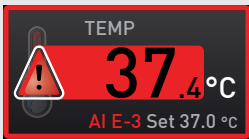
Error description	Cause of error	Rectifying errors	See
Displays are dark	External power supply was interrupted	Check the power supply	page 21
	Miniature fuse, appliance fuse or power module faulty	Contact customer service	page 2
Displays cannot be activated	Appliance locked by user ID	Unlock with user ID	page 53
	Appliance is in programme or timer mode	Wait for end of programme or timer	
Displays suddenly look different	Appliance is in "wrong" mode	Change to operating or menu mode by pressing the MENU key	
Display T:E-3 in the temperature display 	Temperature operating sensor defective. The monitoring sensor takes over the measurement function.	<ul style="list-style-type: none"> ▶ The appliance can be temporarily operated ▶ Contact customer service as soon as possible 	page 2

Error description	Cause of error	Rectifying errors	See
Error message AI E-3 in the temperature display 	Temperature monitoring sensor defective. The operating sensor takes over the measurement function.	<ul style="list-style-type: none"> ▶ The appliance can temporarily be kept in service ▶ Contact customer service as soon as possible 	page 2
Error message E-3 in the temperature display 	Operating and monitoring sensor defective	<ul style="list-style-type: none"> ▶ Switch off appliance. ▶ Remove the chamber load ▶ Contact customer service 	page 2

6.3 Power failure



Warning!

Depending on the operation performed, the surfaces in the interior and the chamber load may still be very hot after power loss. Additionally, depending on the duration of the power loss, the appliance might heat up again after power supply has been restored (see below). Touching these surfaces can cause burns. Wear heat-resistant protective gloves or wait until the appliance cools down first.



In case of a power failure, the appliance operates as follows:

In manual mode

After power supply has been restored, operation is continued with the parameters set. The time and duration of the power failure are documented in the log memory.

In timer or programme mode

In case of an interruption of the power supply of less than 60 minutes, the current programme is continued from the point at which it was interrupted. For interruptions of the power supply longer than this, all appliance functions (heating, fan etc.) are switched off and the air flap is opened.

In timer or programme mode of sterilisers

After power supply has been restored, the timer or programme always starts again from the beginning.

7. Menu mode

In menu mode, you can make basic settings, load programmes and export protocols, as well as adjust appliance parameters.

Caution:

1 Before changing menu settings, read the description of the respective functions on the following pages to avoid possible damage to the appliance and/or chamber load.

To enter menu mode, press the MENU key.

1 To exit the menu mode at any time, press the MENU key again. The appliance then returns to manual mode. Only changes accepted by pressing the confirmation key are saved.

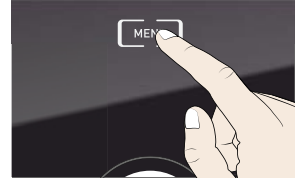

7.1 Overview

Press the MENU key to change between the displays in menu mode:

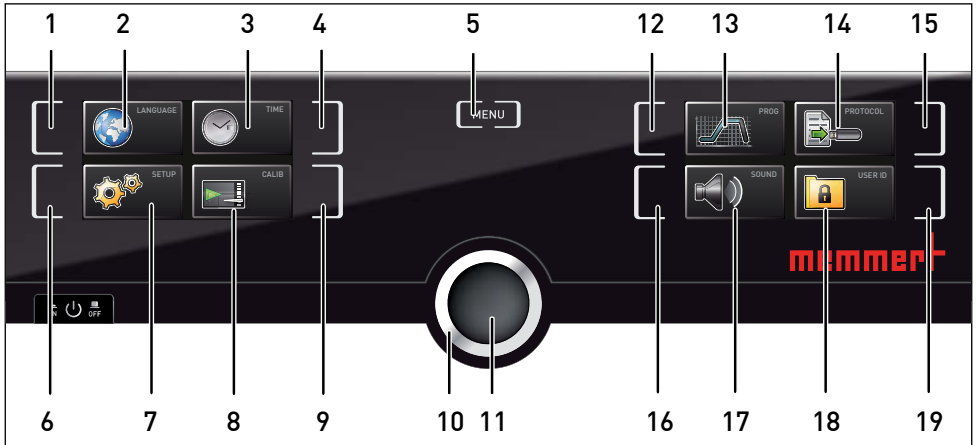

Fig. 22 ControlCOCKPIT in menu mode

- | | |
|--|--|
| <ul style="list-style-type: none"> 1 Language selection activation key 2 Language selection display 3 Date and time display 4 Date and time setting activation key 5 Exit menu mode and return to manual mode 6 Setup activation key (basic appliance settings) 7 Setup display (basic appliance settings) 8 Adjustment display 9 Adjustment activation key 10 Turn control for adjustment | <ul style="list-style-type: none"> 11 Confirmation key (accepts setting made with the turn control) 12 Programme setup activation key 13 Programme setup display 14 Protocol display 15 Protocol activation key 16 Acoustic signal adjustment activation key 17 Acoustic signal adjustment display 18 User ID display 19 User ID activation key |
|--|--|

7.2 Basic operation in menu mode using the example of language selection

In general, all settings in menu mode are done just like in manual mode: Activate the respective display, use the turn control for setting and press the confirmation key to accept the change. A more detailed description is provided in the following, using the example of language selection.

1. Activate the desired parameter (in this example the language). To do so, press the corresponding activation key on the left or right of the respective display. The activated display is enlarged.

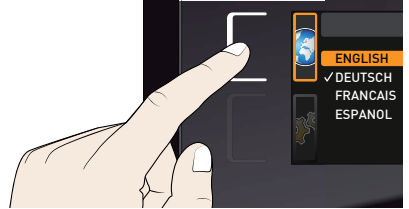

- i** If you want to exit or cancel your settings, again press the activation key which you have used to activate the display. The appliance returns to the menu overview. Only the settings that you have confirmed by pressing the confirmation key before cancelling the setting procedure are accepted.



2. With the turn control, select the desired new setting, e.g. Español (Spanish).



3. Save the setting by pressing the confirmation key.

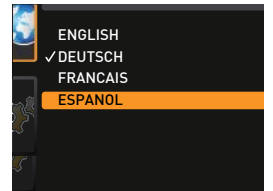
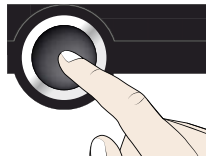

4. To return to the menu overview, press the activation key again.



You can now

- ▶ activate another menu function by pressing the corresponding activation key or
- ▶ return to manual mode by pressing the MENU key.

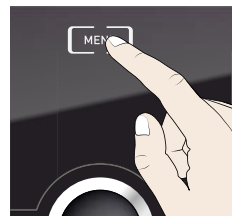

All other settings can be made accordingly. The settings possible are described in the following sections.

1 If no new values are entered or confirmed for approx. 30 seconds, the appliance automatically returns to the main menu and restores the former values.

7.3 Setup

7.3.1 Overview

In the **SETUP** display, you can set the following parameters:

- ▶ the **IP address** and **Subnet mask** of the appliance's Ethernet interface (for connection to a network)
- ▶ the **Unit** of the temperature display (°C or °F, see page 41)
- ▶ **Alarm temp**: the temperature protection class according to DIN 12 880:2007-5 (TWW or TWB, see pages 42 and 29)
- ▶ the **Timer mode** (see page 43)
- ▶ the type of the slide-in unit (Grid or Shelf, see page 44)
- ▶ the heat output distribution (**Balance**, see page 44)

1 If the **SETUP** menu contains more entries than can be displayed, this is indicated by the display "1/2". This means that there is a second „page“ of entries.

To display the hidden entries, use the turn control to scroll beyond the lowest entry. The page display changes to "2/2".

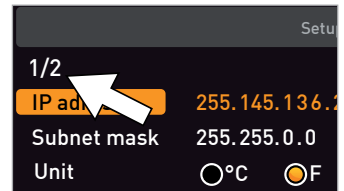

7.3.2 IP address and subnet mask

If you want to operate one or more appliances in a network, each appliance must have its own unique IP address for identification. By default, each appliance is delivered with the IP address 192.168.100.100.

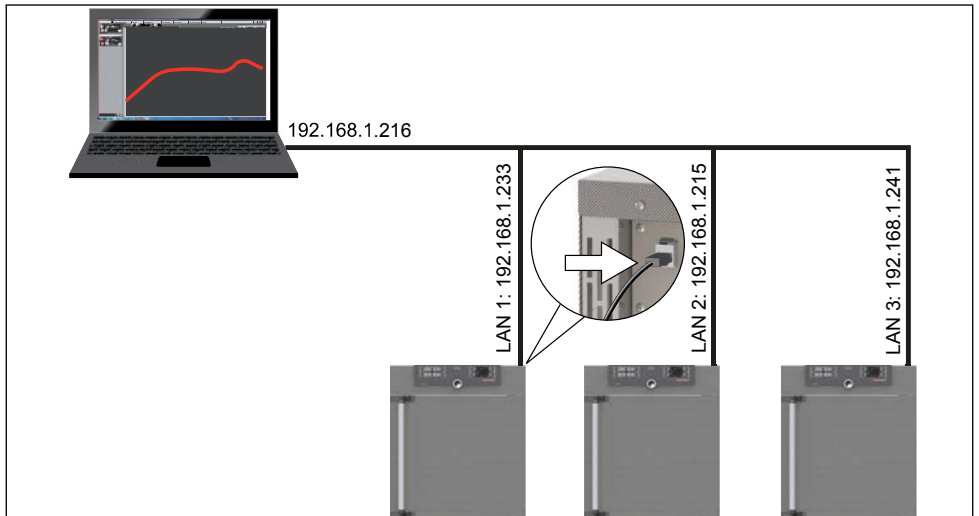
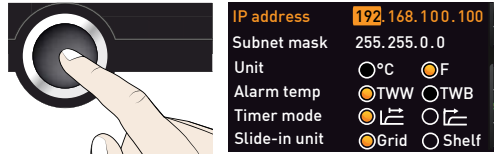

Fig. 23 Operation of several appliances in a network (schematic example)

1. Activate the **SETUP** display. The entry **IP address** is automatically highlighted.



2. Accept the selection by pressing the confirmation key. The first three digits of the IP address are automatically selected.



3. With the turn control, set the new number, e.g. 255.

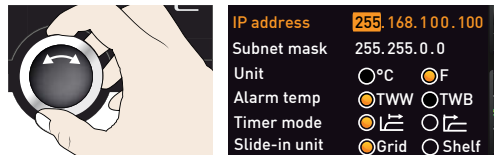

4. Accept the selection by pressing the confirmation key. The next three digits of the IP address are automatically selected. Setting these is done according to the description above.

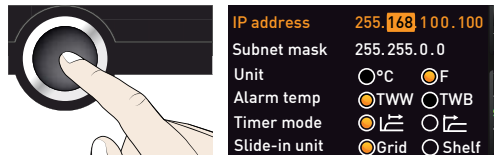

5. After setting the last three digits, accept the new IP address by pressing the confirmation key. The selection returns to the overview.

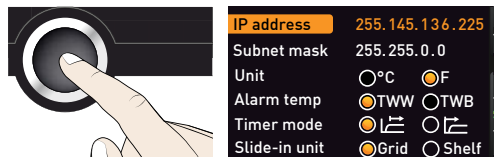

The subnet mask is set accordingly.

7.3.3 Unit

Here, you can choose whether the temperature is displayed in °C or °F.

1. Activate the **SETUP** display and select **Unit** with the turn control.

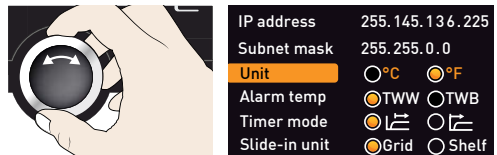

2. Accept the selection by pressing the confirmation key. The adjustment options are automatically highlighted.

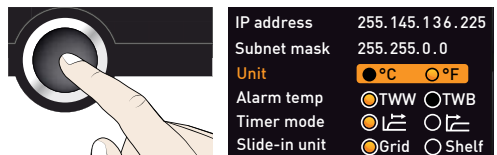

- With the turn control, select the desired unit – in this example °C.



IP address	255.145.136.225
Subnet mask	255.255.0.0
Unit	<input checked="" type="radio"/> °C <input type="radio"/> °F
Alarm temp	<input checked="" type="radio"/> TWW <input type="radio"/> TWB
Timer mode	<input checked="" type="radio"/> <input type="radio"/>
Slide-in unit	<input checked="" type="radio"/> Grid <input type="radio"/> Shelf

- Save the setting by pressing the confirmation key.

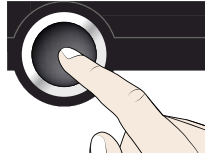

IP address	255.145.136.225
Subnet mask	255.255.0.0
Unit	<input checked="" type="radio"/> °C <input type="radio"/> °F
Alarm temp	<input checked="" type="radio"/> TWW <input type="radio"/> TWB
Timer mode	<input checked="" type="radio"/> <input type="radio"/>
Slide-in unit	<input checked="" type="radio"/> Grid <input type="radio"/> Shelf

7.3.4 Temperature monitoring

Here, you can choose which temperature protection class in accordance with DIN 12 880:2007-5 should be used (TWW or TWB, description from page 29).

- Activate the **SETUP** display and select **Alarm temp** with the turn control.



IP address	255.145.136.225
Subnet mask	255.255.0.0
Unit	<input checked="" type="radio"/> °C <input type="radio"/> °F
Alarm temp	<input checked="" type="radio"/> TWW <input type="radio"/> TWB
Timer mode	<input checked="" type="radio"/> <input type="radio"/>
Slide-in unit	<input checked="" type="radio"/> Grid <input type="radio"/> Shelf

- Accept the selection by pressing the confirmation key. The adjustment options are automatically highlighted.

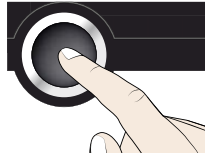

IP address	255.145.136.225
Subnet mask	255.255.0.0
Unit	<input checked="" type="radio"/> °C <input type="radio"/> °F
Alarm temp	<input checked="" type="radio"/> TWW <input checked="" type="radio"/> TWB
Timer mode	<input checked="" type="radio"/> <input type="radio"/>
Slide-in unit	<input checked="" type="radio"/> Grid <input type="radio"/> Shelf

- With the turn control, select the desired setting – in this example TWB.



IP address	255.145.136.225
Subnet mask	255.255.0.0
Unit	<input checked="" type="radio"/> °C <input type="radio"/> °F
Alarm temp	<input type="radio"/> TWW <input checked="" type="radio"/> TWB
Timer mode	<input checked="" type="radio"/> <input type="radio"/>
Slide-in unit	<input checked="" type="radio"/> Grid <input type="radio"/> Shelf

- Save the setting by pressing the confirmation key.

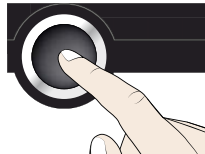

IP address	255.145.136.225
Subnet mask	255.255.0.0
Unit	<input checked="" type="radio"/> °C <input type="radio"/> °F
Alarm temp	<input type="radio"/> TWW <input checked="" type="radio"/> TWB
Timer mode	<input checked="" type="radio"/> <input type="radio"/>
Slide-in unit	<input checked="" type="radio"/> Grid <input type="radio"/> Shelf

i The temperature monitoring settings are made in manual mode (see page 32).

7.3.5 Timer mode

For universal ovens UN^{PLUS}/UF^{PLUS} and incubators IN^{PLUS}/IF^{PLUS}, you can choose if the timer (see page 27) should run setpoint-dependent or not – this determines if the timer should not start until a tolerance band of ± 3 K around the set temperature is reached (Fig. 24, B) or if it should start right after activation (A).

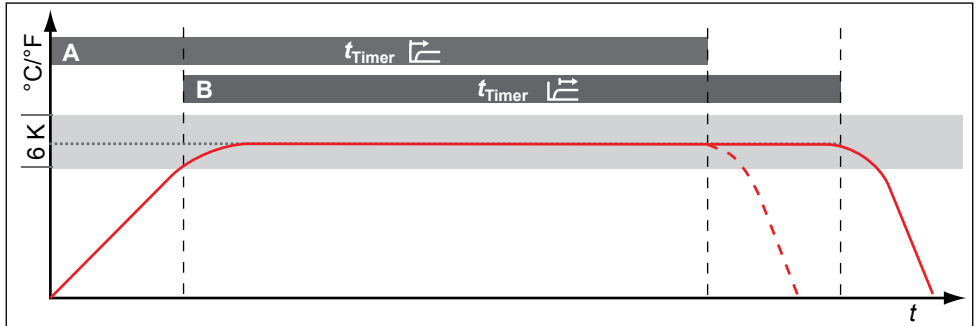

Fig. 24 Timer mode

- A Timer independent of setpoint: Timer starts right after activation
- B Timer setpoint-dependent: Timer does not start until tolerance band is reached

i For sterilisers SN^{PLUS}/SF^{PLUS}, the timer is by default setpoint-dependent. To ensure that the required temperature is maintained for a sufficient period of time, this setting cannot be changed. If the temperature is no longer within the tolerance band, the sterilisation time is, for reasons of safety, restarted as soon as the required temperature is reached again. For universal ovens UN^{PLUS}/UF^{PLUS} and incubators IN^{PLUS}/IF^{PLUS}, the timer is in this case interrupted and resumed as soon as the required temperature is reached again.

Setting

1. Activate the **SETUP** display and select **Timer mode** with the turn control.



IP address	255.145.136.225
Subnet mask	255.255.0.0
Unit	<input checked="" type="radio"/> °C <input type="radio"/> °F
Alarm temp	<input type="radio"/> TWW <input checked="" type="radio"/> TWB
Timer mode	<input checked="" type="radio"/> <input type="radio"/>
Slide-in unit	<input checked="" type="radio"/> Grid <input type="radio"/> Shelf

2. Accept the selection by pressing the confirmation key. The adjustment options are automatically highlighted.

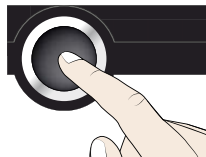

IP address	255.145.136.225
Subnet mask	255.255.0.0
Unit	<input checked="" type="radio"/> °C <input type="radio"/> °F
Alarm temp	<input type="radio"/> TWW <input checked="" type="radio"/> TWB
Timer mode	<input type="radio"/> <input checked="" type="radio"/>
Slide-in unit	<input checked="" type="radio"/> Grid <input type="radio"/> Shelf

3. With the turn control, select the desired setting – in this example Timer independent of setpoint ().



IP address	255.145.136.225
Subnet mask	255.255.0.0
Unit	<input type="radio"/> °C <input type="radio"/> °F
Alarm temp	<input type="radio"/> TWW <input checked="" type="radio"/> TWB
Timer mode	<input checked="" type="radio"/> <input type="radio"/>
Slide-in unit	<input checked="" type="radio"/> Grid <input type="radio"/> Shelf

4. Save the setting by pressing the confirmation key.

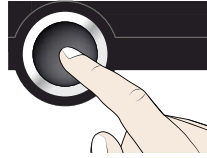

IP address	255.145.136.225
Subnet mask	255.255.0.0
Unit	<input checked="" type="radio"/> °C <input type="radio"/> °F
Alarm temp	<input type="radio"/> TWW <input checked="" type="radio"/> TWB
Timer mode	<input type="radio"/> <input checked="" type="radio"/>
Slide-in unit	<input checked="" type="radio"/> Grid <input type="radio"/> Shelf

7.3.6 Type of the slide-in unit (Grid or Shelf)

Here, you have to set the type of the slide-in unit (grid or shelf) used. The selection Shelf enables you to adjust the control function to the different air flow characteristics in the interior when using optional sliding shelves instead of the grids that are part of the standard delivery.

1. Activate the **SETUP** display and select **Slide-in unit** with the turn control.



IP address	255.145.136.225
Subnet mask	255.255.0.0
Unit	<input checked="" type="radio"/> °C <input type="radio"/> °F
Alarm temp	<input type="radio"/> TWW <input checked="" type="radio"/> TWB
Timer mode	<input type="radio"/> <input type="radio"/>
Slide-in unit	<input checked="" type="radio"/> Grid <input type="radio"/> Shelf

2. Accept the selection by pressing the confirmation key. The adjustment options are automatically selected.

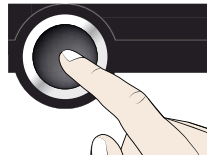

IP address	255.145.136.225
Subnet mask	255.255.0.0
Unit	<input checked="" type="radio"/> °C <input type="radio"/> °F
Alarm temp	<input type="radio"/> TWW <input checked="" type="radio"/> TWB
Timer mode	<input checked="" type="radio"/> <input type="radio"/>
Slide-in unit	<input type="radio"/> Grid <input checked="" type="radio"/> Shelf

3. With the turn control, select the desired setting – in this example **Shelf**.



IP address	255.145.136.225
Subnet mask	255.255.0.0
Unit	<input checked="" type="radio"/> °C <input type="radio"/> °F
Alarm temp	<input type="radio"/> TWW <input checked="" type="radio"/> TWB
Timer mode	<input checked="" type="radio"/> <input type="radio"/>
Slide-in unit	<input type="radio"/> Grid <input checked="" type="radio"/> Shelf

4. Save the setting by pressing the confirmation key.

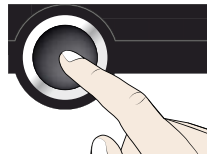

IP address	255.145.136.225
Subnet mask	255.255.0.0
Unit	<input checked="" type="radio"/> °C <input type="radio"/> °F
Alarm temp	<input type="radio"/> TWW <input checked="" type="radio"/> TWB
Timer mode	<input checked="" type="radio"/> <input type="radio"/>
Slide-in unit	<input type="radio"/> Grid <input checked="" type="radio"/> Shelf

7.3.7 Balance

Description

For appliances of the size 55 and above, application-specific correction of the heat output distribution (balance) between the upper and lower heating groups is possible. The adjustment range is from -50 % to +50 %.

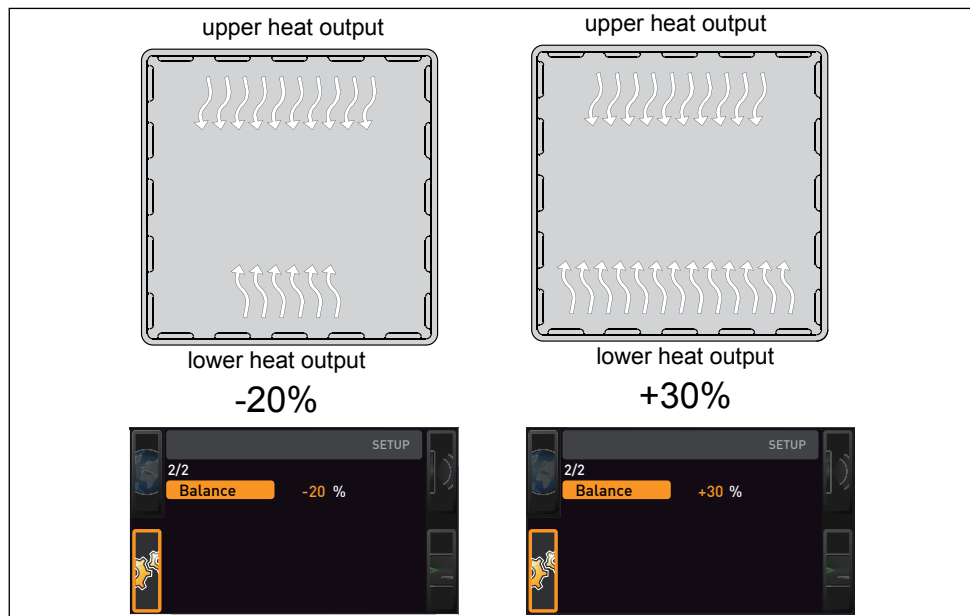
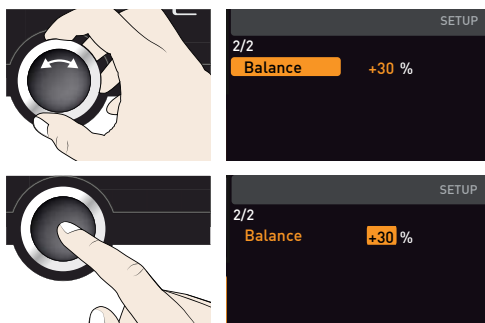

Fig. 25 Heat output distribution (example): The -20 % (left) setting causes the lower heating groups to emit 20 % less heat than the upper ones. The +30 % (right) setting causes the lower heating groups to emit 30 % more heat than the upper ones. The 0 % setting restores the default heat output distribution.

Setting

1. Activate the **SETUP** display and select **Balance** with the turn control.
2. Save the selection by pressing the confirmation key. The current selection – in this example +30 % – is automatically highlighted.



- With the turn control, select the desired new setting, e.g. +50 %.

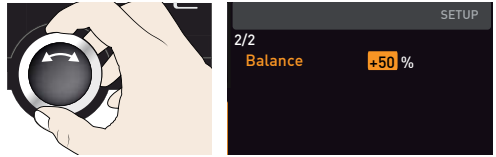

- Save the setting by pressing the confirmation key. The selection returns to the overview.

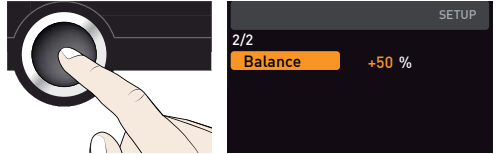

7.4 Date and Time

In the Time display, you can set date and time, time zone and daylight saving time.

i Please always set the time zone and daylight saving time before setting the date and time.

- Activate the time setting. To do so, press the activation key on the right side of the Time display. The display is enlarged and the first adjustment option (Date) automatically highlighted.

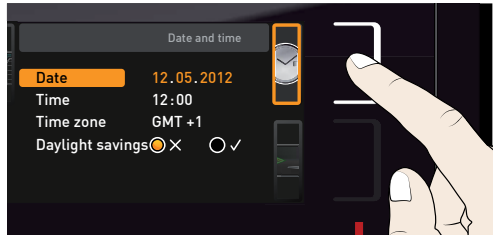

- Turn the turn control until Time zone is highlighted.

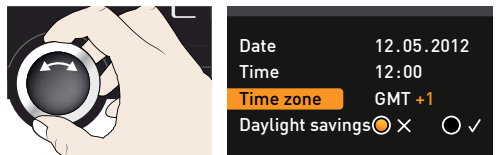

- Accept the selection by pressing the confirmation key.

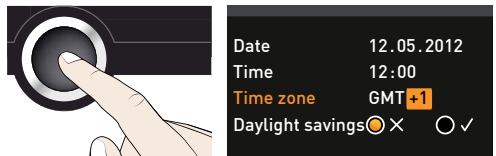

- Set the time zone of the installation site with the turn control, e.g. 0 for France, Spain or Great Britain (also refer to Fig. 26). Accept the selection by pressing the confirmation key.

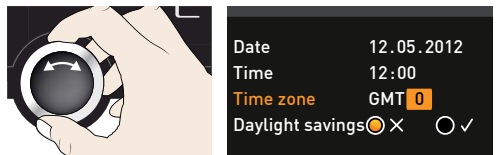

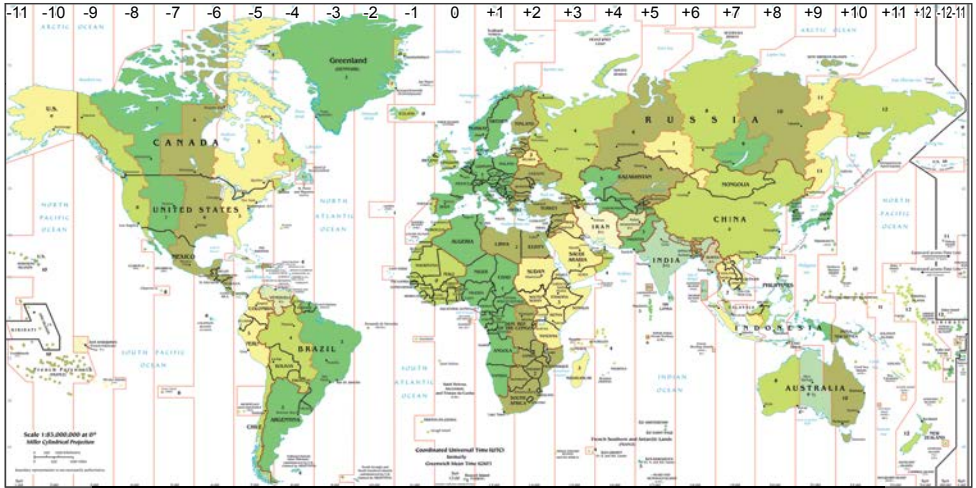
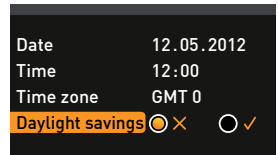
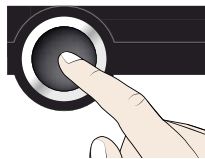

Fig. 26 Time zones

5. With the turn control, select the Daylight savings entry



6. Accept the selection by pressing the confirmation key. The adjustment options are highlighted.



7. Set daylight savings to off (X) or on (✓) with the turn control – in this case on (✓). Save the setting by pressing the confirmation key.

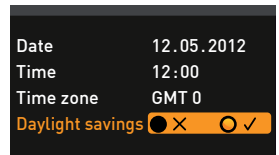

i Daylight saving time and standard time are not changed automatically. For this reason, please keep in mind to adjust them at the beginning of each period.

8. Now, set date (day, month year) and time (hours, minutes) in the same way. Accept the selection by pressing the confirmation key.

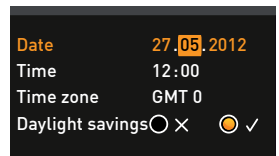

7.5 Calibration

The appliances are temperature calibrated and adjusted at the factory. In case readjustment should be necessary later on – for example due to influence of the chamber load – the appliance can be calibrated customer-specifically using three calibration temperatures of your choice:

- ▶ Cal1 Temperature calibration at low temperature
- ▶ Cal2 Temperature calibration at medium temperature
- ▶ Cal3 Temperature calibration at high temperature

To guarantee perfect control, we recommend to calibrate the appliance once a year.

i For temperature adjustment, you will need a calibrated reference measuring device.

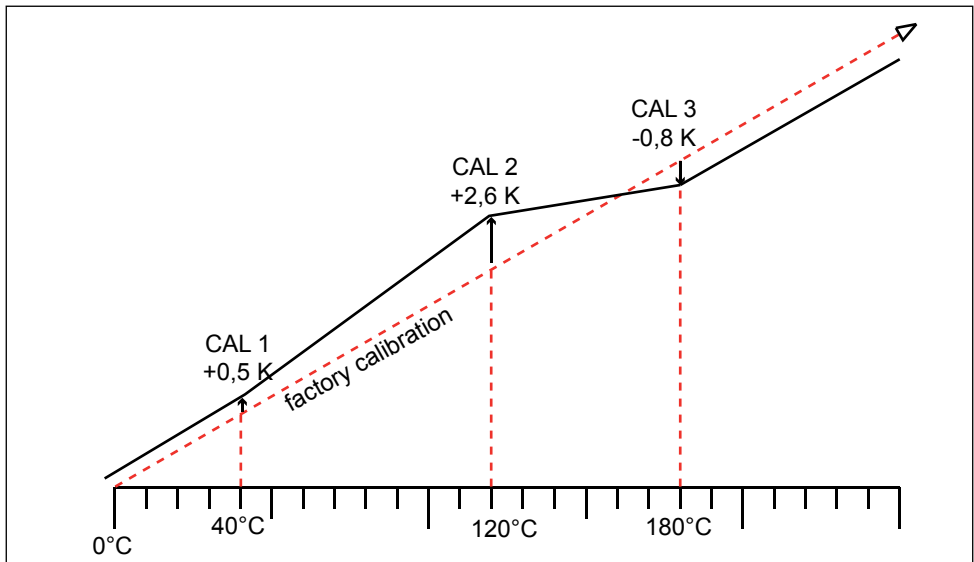

Fig. 27 Schematic example of temperature adjustment

Example: Temperature deviation at 120 °C should be corrected.

1. Activate the adjustment setting. To do so, press the activation key on the right side of the CALIB display. The display is enlarged and the first calibration temperature – in this case 40 °C – automatically highlighted.



2. Press the confirmation key repeatedly, until the calibration temperature Cal2 is selected.

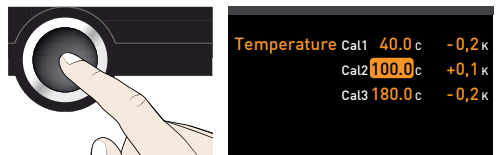

3. With the turn control, set the calibration temperature Cal2 to 120 °C.



Temperature	Cal1	40.0 c	-0,2 K
	Cal2	120.0 c	+0,1 K
	Cal3	180.0 c	-0,2 K

4. Save the setting by pressing the confirmation key. The corresponding calibration value is automatically highlighted.

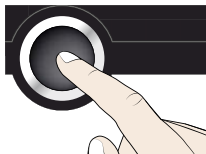

Temperature	Cal1	40.0 c	-0,2 K
	Cal2	120.0 c	+0,1 K
	Cal3	180.0 c	-0,2 K

5. Set the calibration value to 0.0 K and accept the setting by pressing the confirmation key.



Calibration			
Temperature	Cal1	40.0 c	-0,2 K
	Cal2	120.0 c	0,0 K
	Cal3	180.0 c	-0,2 K

6. Position the sensor of a calibrated reference instrument centrally in the appliance's working chamber.

7. Close the door and, in manual mode, adjust the set temperature to 120 °C.

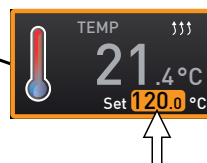
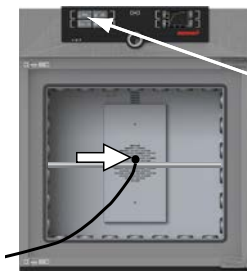

8. Wait until the appliance reaches the set temperature and displays 120 °C. The reference instrument for example displays 122.6 °C.

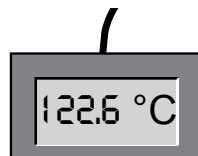
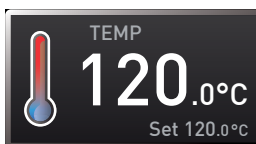

9. In the SETUP, adjust the calibration value Cal2 to +2.6 K (actual value measured minus setpoint temperature) and save the setting by pressing the confirmation key.



Temperature	Cal1	40.0 c	-0,2 K
	Cal2	120.0 c	+2,6 K
	Cal3	180.0 c	-0,2 K

10. After the calibration procedure, the temperature measured by the reference instrument should now also be 120 °C.

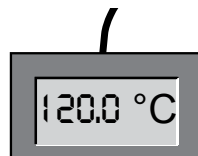
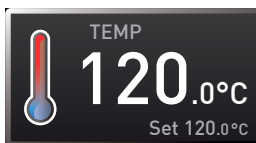

With Cal1, a calibration temperature below Cal2 can be programmed accordingly, and with Cal3, a temperature above. The minimum difference between the Cal values is 20 K for universal ovens UN^{PLUS}/UF^{PLUS} as well as sterilisers SN/SF and 10 K for incubators IN/IF.

i If all calibration values are set to 0.0 K, the factory calibration settings are restored.

7.6 Programme

In the PROG display, you can transfer programmes created using AtmoCONTROL software and saved on a USB storage medium to the appliance. Here, you can also select the programme to be used in manual mode (see page 28) and delete programmes.

i To load a programme from a USB storage medium : Connect the USB storage medium with the saved programme(s) to the interface on the right side of the control panel.

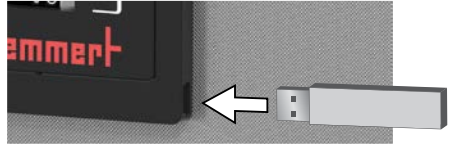

1. Activate the programme display. To do so, press the activation key on the left side of the PROG display. The display is enlarged and the entry **Select** automatically highlighted. The programmes available for activation are shown on the right. The programme currently available for use – in this example **Test 012** – is highlighted in orange.

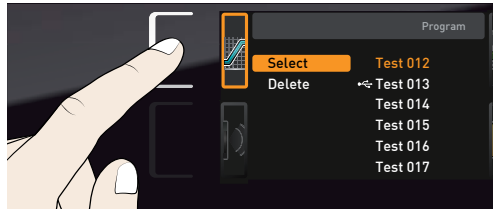

2. Call the **Select** function by pressing the confirmation key. All programmes available are displayed, including the ones saved on the USB storage medium (identified by the USB symbol). The programme currently available for use is highlighted in orange.

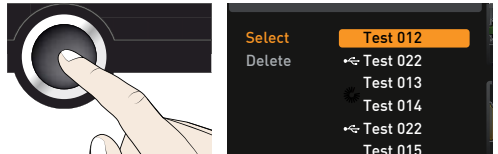

3. With the turn control, select the programme you want to make available for use.

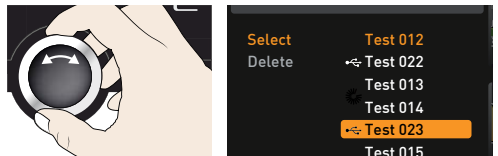

4. Accept the selection by pressing the confirmation key. The programme is now loaded, which is indicated by the transfer symbol.

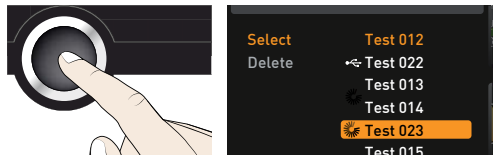

5. As soon as the programme is ready, the selection returns to **Select**. To start the programme: Return to manual mode by pressing the MENU key and start programme as described on page 28.

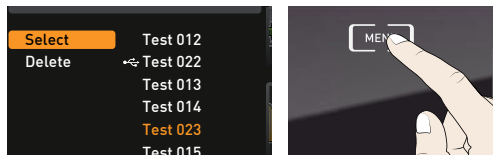

You can now remove the USB storage medium.

To delete a programme, select **Delete** with the turn control and select the programme to be deleted the same way you can select a programme for activation.

7.7 Sound

In the **SOUND** display, you can define whether or not the appliance should emit acoustic signals and, if yes, define on which events it should do so:

- ▶ on the press of a key
- ▶ at the end of a programme
- ▶ on alarm
- ▶ if the door is open

1. Activate the acoustic signal adjustment.

To do so, press the activation key on the left side of the **SOUND** display. The display is enlarged. The first category (in this case **Key sound**) is automatically highlighted. On the right, the current settings are shown on.

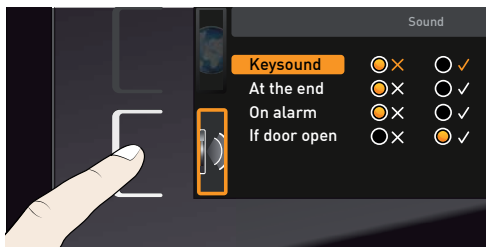

- i** If you want to edit another list entry: Turn the turn control until the respective entry – e.g. **If door open** (Special accessories) – is highlighted in colour.

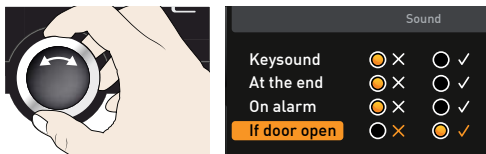

2. Save the selection by pressing the confirmation key. The adjustment options are automatically highlighted.

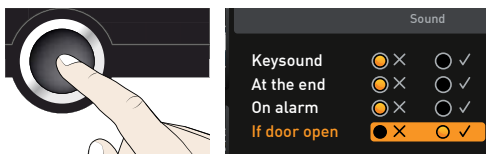

3. With the turn control, select the desired setting – in this example OFF (X).

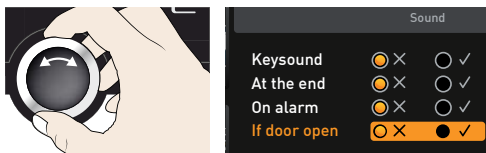

4. Save the setting by pressing the confirmation key.

- i** If an acoustic alarm sounds, it can be turned off by pressing the confirmation key.

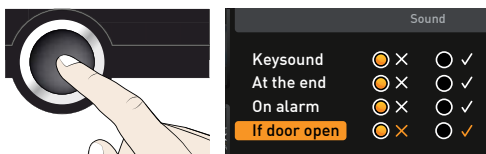

7.8 Protocol

The appliance continually logs all relevant measured values, settings and error messages at 1-minute intervals. The internal log memory is of the continuous memory type. The logging function cannot be switched off and is always active. The measured data are stored in the appliance, safe from manipulation. If the power supply is interrupted, the time of the power failure and voltage recovery are stored in the appliance.

You can export the protocol data for different periods to a USB storage medium via the USB interface or, via Ethernet, import them to the AtmoCONTROL software for graphical representation, print-out or storage.

i The log memory of the appliance is not modified or deleted by reading it out.

1. Connect the USB storage medium to the interface on the right side of the control panel.

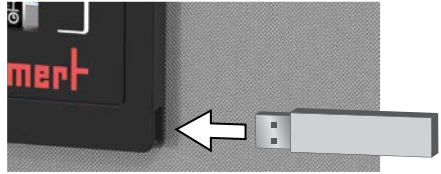

2. Activate the protocol. To do so, press the activation key on the right side of the **PROTOCOL** display. The display is enlarged and the period **1 week** automatically highlighted. To select another logging period, use the turn control.

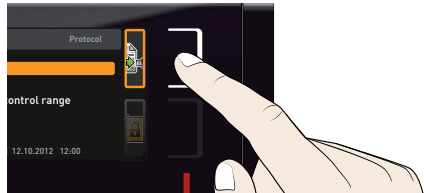

3. Save your selection by pressing the confirmation key. The transfer starts and a status symbol indicates the progress.

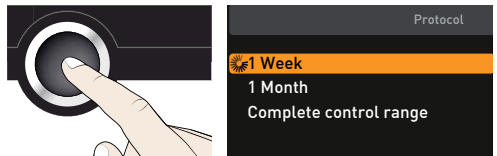

4. As soon as the transfer is complete, a check mark appears in front of the period selected. You can now remove the USB storage medium.

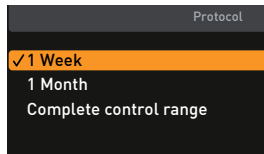

For a description of how to import and process protocol data in AtmoCONTROL or read them out via Ethernet, please observe the separate AtmoCONTROL manual.

7.9 User ID

7.9.1 Description

With the User-ID function, you can lock the settings of individual (e.g. temperature) or all parameters, so that they cannot be changed at the appliance by accident or unauthorised persons. You can also lock setting options in menu mode (e.g. adjustment or date and time settings) this way.

● If adjustment options are locked, this is indicated by **1** the lock symbol in the respective display (Fig. 28).

User ID data are entered in the AtmoCONTROL software and saved on the USB storage medium. The USB storage medium is thus acting as a key: Parameters can only be locked or unlocked if it is connected.

● A description of how to create a user ID in **1** AtmoCONTROL is provided in the separate AtmoCONTROL manual.

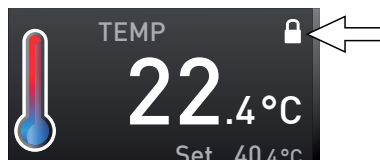
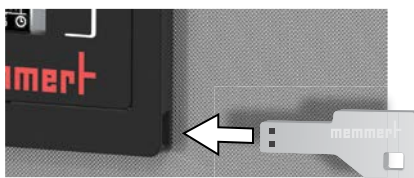

Fig. 28 Temperature adjustment at appliance locked (example)

7.9.2 User ID activation and deactivation

1. Connect the USB storage medium with the user ID data to the interface on the right side of the control panel.
2. Activate the user ID. To do so, press the activation key on the right side of the **USER-ID** display. The display is enlarged and the entry **Activate** automatically highlighted.



3. Confirm the activation by pressing the confirmation key. The new user ID data are transferred from the USB storage medium and activated. As soon as activation is complete, a check mark appears in front of the corresponding entry.
4. Remove the USB storage medium. Locked parameters are indicated by the lock symbol in the respective display (Fig. 28).

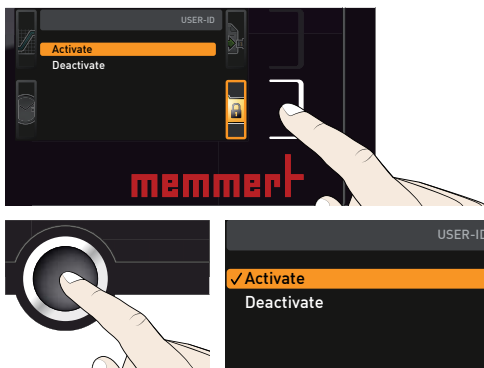

To unlock the appliance, connect the USB storage medium, activate the **USER-ID** entry and select **Deactivate**.

8. Sterilisers SF^{PLUS}/SN^{PLUS}

8.1 Intended use

The SF^{PLUS}/SN^{PLUS} appliance serves for sterilising medical material through dry heated air at atmospheric pressure.

8.2 Note in accordance with Medical Devices Directive

The product lifetime as intended by the manufacturer is eight years.

8.3 Guidelines for sterilisation

For hot air sterilisation, there are different guidelines on the temperature and sterilisation time to choose, as well as on packaging the sterilisation load. The values to be chosen depend on the type and characteristics of the load to be sterilised and on the type of germs to be neutralised. Before beginning sterilisation, make yourself familiar with the sterilisation method laid down for your application.

Process parameters for hot air sterilisers are temperature and minimum hold time. The following process parameters have been defined in recognised standards:

- ▶ According to WHO: 180 °C with a minimum hold time of 30 min
- ▶ According to the European Pharmacopoeia: 160 °C with a minimum hold time of 120 min

For the inactivation of endotoxin (pyrogenes), dry heat of at least 180 °C can be applied. For the depletion of pyrogenic substances, you have to keep a combination of temperature and time going beyond the requirements of sterilisation.

Inactivation of endotoxin is possible using the following process parameters (data in accordance with ISO 20857:2010):

- ▶ 180 °C with a minimum effective time of 180 min
- ▶ 250 °C with a minimum effective time of 30 min

● **Caution:**

i The temperature and time requirements normal for hot air sterilisation do not destroy endotoxins.

Especially when the appliance is heavily loaded, using these parameters without checking them will not be sufficient. For safe sterilisation, validation of the individual sterilisation process is required. The requirements for the validation of sterilisation by dry heat are e.g. defined in standard ISO 20857:2010. Also valuable is the "guideline on validation and routine monitoring of sterilisation processes using dry heat for medical products" issued by the German Society for Hospital Hygiene (DGKH).

Sterilisers SF^{PLUS}/SN^{PLUS}/IF^{PLUS}/IN^{PLUS} feature default sterilisation programmes saved in the appliance, which cannot be changed or deleted. A description of how to activate them is provided from page 50, their use is described from page 28. We recommend to always use these programmes for sterilisation.

- If the process parameters are set manually,
- i** setpoint-dependent operation is automatically selected.

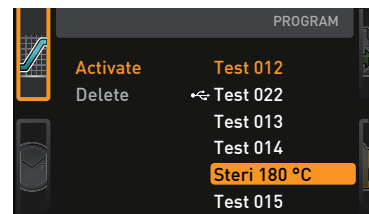

9. Maintenance and service

9.1 Cleaning

**Warning!**

Danger of injury by electric shock. Before any cleaning work, pull out the mains plug.

**Warning!**

In case of appliances of a certain size, you can get accidentally locked in, which is life-threatening. Do not climb into the appliance!

9.1.1 Working chamber and metal surfaces

Regular cleaning of the easy-to-clean working chamber prevents build up of material remains that could impair the appearance and functionality of the stainless steel working chamber over time.

The metal surfaces of the appliance can be cleaned with normal stainless steel cleaning agents. Make sure that no rusty objects come into contact with the working chamber or with the stainless steel housing. Rust deposits can lead to an infection of the stainless steel. If rust spots should appear on the surface of the working chamber due to impurities, the affected area must be immediately cleaned and polished.

9.1.2 Plastic parts

Do not clean the ControlCOCKPIT and other plastic parts of the appliance with caustic or solvent-based cleaning agents.

9.1.3 Glass surfaces

Glass surfaces can be cleaned with a commercially available glass cleaner.

9.2 Regular maintenance

Once a year, grease the moving parts of the doors (hinges and lock) with thin silicone grease and check that the hinge screws are not loose.

To guarantee perfect control, we recommend to calibrate the appliance once a year (see page 48).

9.3 Repairs and service

**Warning!**

After removing covers, live parts may be exposed. You may receive an electric shock if you touch these parts. Disconnect the mains plug before removing any covers. Any work inside the appliance may only be performed by qualified electricians.



Repairs and service work are described in a separate service manual.

10. Storage and disposal

10.1 Storage

The appliance may only be stored under the following conditions:

- ▶ in a dry and enclosed, dust-free room
- ▶ frost-free
- ▶ disconnected from the power supply

10.2 Disposal

This product is subject to the Directive 2002/96/EC on Waste Electrical and Electronic Equipment (WEEE) of the European Parliament and of the Council. This appliance has been brought to market after August 13th, 2005 in countries which have already integrated this directive into their national laws. It may not be disposed of in normal household waste. For disposal, please contact your dealer or the manufacturer. Any appliances that are infected, infectious or contaminated with materials hazardous to health are excluded from return. Please also observe all other regulations applicable in this context.

Before disposing of the appliance, please render the door locking mechanism unusable, for example, to prevent playing children from being locked inside the appliance.

Note for Germany:

The appliance may not be left at public or communal recycling or collection points.

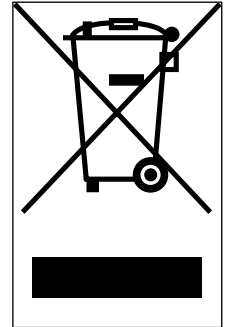

Index

- A**
Accessories 16
Acoustic signals 48
Activation key 25
Adjustment 48
Air flap position 26
Air supply 11
Alarm 32, 35
Alarm temperature 42
Ambient conditions 15, 16
Ambient temperature 16
Appliance error 36
ASF 29, 32
AtmoCONTROL 3, 12, 16, 25, 28, 50, 52, 53
Automatic temperature monitor 31
- B**
Basic device settings 38
Basic settings 38
- C**
CALIB 48
Calibration 48
Carrying 17
Cause of errors 36
Chamber load 23
Changes 9
Cleaning 55
Clock time 46
Communication interfaces 12
Compensation correction value 50
Connections 12
ControlCOCKPIT 10, 24
Convection 11
Customer service 2
- D**
Declaration of conformity 15
Decommissioning 56
Delete programme 51
Delivery 17, 21, 54
Dimensions 15
Disposal 56
Door 22
- E**
Electrical connection 12
Electronic temperature monitoring 30
Emergency 9
Ending operation 34
End of programme 29
Error description 36
Error messages 35
Ethernet 12
Explosion protection 8
- F**
factory calibration settings 50
Fan speed 26
Fehlermeldung 36, 37
Forklift truck 17
Function 11
- G**
Graph 34
Grid 44
- H**
Hazards 7
Heat output distribution 45
- I**
Installation site 18
Intended use 8
Interfaces 12
Interior lighting 26
IP address 40
- L**
Language selection 39
Lighting 26
Loading the appliance 23
Log memory 37, 52
- M**
Maintenance 55
Malfunctions 9, 35
Manufacturer 2
Material 11
Mechanical temperature monitoring 32
Medical device 8
Medical Devices Directive 54
Menu 38, 46
Minimum clearances 18
Monitoring temperature 30
- N**
Nameplate 13
Network 12, 40
Normal mode 25, 26
- O**
Operating 22
Operating modes 25
Operating personnel 7, 22
Operating problems 36
Operation 22
- P**
Packaging material 17
Power failure 37
Power supply 52
Press of a key 51
Product safety 7
Programme 50
Programme mode 25, 28
Pt100 temperature sensor 30
Putting into operation 21, 54
- R**
Rectifying errors 36
Regular maintenance 55
- S**
Safety regulations 6
Service 55
Servicing 55
Setting parameters 25, 39
Setting up 17, 18
Setting up options 19
Setup 40
Shelf 44
Slide-in unit 44
Speaker symbol 35
Sterilisation programme 54
Sterilisers 3, 22, 27, 43, 54
Storage after delivery 18
Switching off 34
Switching on 21
-

T

TB 32
Technical data 14
Temperature 26
Temperature comparison 48
Temperature deviation 48
Temperature limiter 32
Temperature monitor 29, 32
Temperature monitoring 29,
42
Temperature sensor 30
Tilt protection 20
Time 44
Timer mode 43
Timer operation 27
Transport 17
Transport damage 17
Turn control 25
TWB 31
TWW 30
TWW temperature monitor-
ing 30, 31

U

Unit 41
Unpacking 17
USB interface 12, 52
User ID 53

W

Warning messages 12, 35
Weight 14



memmert
Experts in Thermostatics

Universal ovens ^{PLUS}

Incubators ^{PLUS}

Sterilisers ^{PLUS}

25.03.2014

D24026 // englisch

Memmert GmbH + Co. KG
Willi-Memmert-Straße 90-96 | D-91186 Büchenbach
Tel. +49 9122 925-0 | Fax +49 9122 14585
E-Mail: sales@memmert.com
[facebook.com/memmert.family](https://www.facebook.com/memmert.family)
Die Experten-Plattform: www.atmosafe.net