



Sauter GmbH

Ziegelei 1
D-72336 Balingen
e-mail: info@kern-sohn.com

Phone : +49-[0]7433- 9933-0
Fax: +49-[0]7433-9933-149
Internet: www.sauter.eu

Instruction manual mobile Leeb hardness tester

SAUTER HMO

Version 2.0
04/2020
GB



PROFESSIONAL MEASURING

HMO-BA-e-2020



SAUTER HMO

V. 2.0 04/2020

Instruction manual mobile Leeb hardness tester

Thank you for purchasing the mobile digital Leeb impact hardness tester from SAUTER. We hope that you will be very satisfied with the high quality of this device and its extensive functionality. For any questions, wishes and suggestions we are at your disposal.

Table of contents:

1	Before commissioning	3
2	Introduction	3
2.1	Measuring principle.....	3
2.2	Structure.....	4
2.3	Technical data.....	5
2.4	Area of application	5
3	Test procedure	6
3.1	Preparation of the device	6
3.2	Preparation of the sample	6
3.3	Test execution	8
3.4	Browsing	8
3.5	Print.....	9
4	Setup	9
4.1	Settings in the main mask	9
4.2	Menu settings	10
5	Care and maintenance	14
5.1	Periodic maintenance	14
5.2	Store.....	14
5.3	Calibration	15
6	Annex	16
6.1	Conversion area	17
6.2	Scope of delivery	17

1 Before commissioning

Before putting the device into operation, check the delivery for any transport damage to the packaging, the plastic case and the device itself. Should this be the case, SAUTER must be contacted immediately.

2 Introduction

2.1 Measuring principle

The measuring principle for the measurements carried out with this dynamic impact hardness tester is physically quite uncomplicated. An impact body with a hard metal tip is hurled against the surface of the test object by the spring force. When the impact body hits the surface, it can be damaged, which ultimately leads to a loss of kinetic energy.

This energy loss is calculated on the basis of velocity measurements, at a certain point in time when the impactor is at a certain distance from the surface, both in the rebound and impact phases.

The fixed magnet in the impact body generates an induction voltage in the simple wire coil of the impact tester. The voltage of the signal is proportional to the speed of the impact body. The signal is processed by the electronics so that the hardness value can be read on the display and then stored.

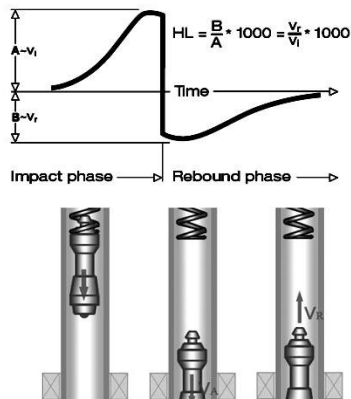

English	German
Impact phase	Impact phase
Rebound phase	Rebound phase
Time	Time

2.2 Structure

2.2.1 Display

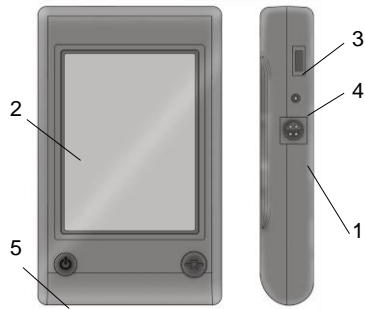

1. impact device socket 2. LCD display 3. mini-USB socket 4. charging socket 5.ON-OFF button

1. impact body
2. support ring
3. bobbin
4. cable
5. pawl clamping device
6. loading pipe
7. release button



Impact device (type D)

The display can be connected to almost any type of Leeb rebound sensor. The rebound sensor is detected automatically.

Take the rebound sensor type D (standard sensor). The description of other types can be found in the appendix (chapter 5).

2.2.2 Display

The rebound hardness tester is equipped with a large LCD touch display.

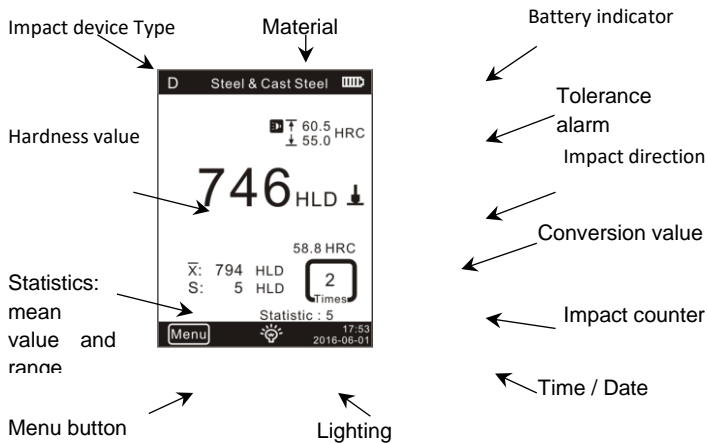

1. Rebound sensor type: automatically detected or manually adjusted
2. materials: Material from which the sample is made
3. Battery indicator
4. Tolerance value
5. Conversion value
IMPORTANT: if this symbol is displayed "---", it means that the conversion is out of range
6. Impact direction

7. Hardness value: measured hardness value L (Leeb)
8. Statistical values: X: Average value S: Range
9. Statistical data: Number of strokes in statistical data
10. Impact counter: number of impacts performed
11. Lighting: Switching on and off by touch
12. Menu: Fade in and out of the setting mask by touch
13. Date / Time: the display of real time and date

2.3 Technical data

- Display range HL: 0~999HLD
- accuracy: ±6 HL
- Display: large LCD display, illumination,
Touch display
- Internal data memory: 500 measured values
- Resolution: 1 (for HL, HV, HB, HSD, MPa); 0,1 (for HRC, HRB)
- Battery: rechargeable Li-Ion
- Operating temperature: 0°C~+50°C (32°F~122°F)
- Storage temperature: -10°C~+60°C (14°F~140°F)
- Dimensions: 130 x 87 x 28 mm
- Weight: 240g

2.4 Scope of application

- Suitable for all metals, ideal for testing production quality
- Optimally suited for testing heavy, large or already installed parts
- Suitable for carrying out measurements in places that are difficult to access
- Automatic adjustment of the impact direction
- Optimal tool for selective testing and acceptance control
- Simple operation and high measuring accuracy for measurements on round surfaces (R > 10 mm)
- Metal production and processing, automotive industry and transport, engineering and power plants, refineries, petrochemical industry, aerospace industry, shipbuilding industry, metal construction, test and laboratory services

3 Test procedure

3.1 Preparation of the device

Connect

Connect the display with the impact device with the signal cable.

Charge battery

Charge the device before first use.

Switch on

Switch on the device  by pressing the button.

Calibration

Before using the test block for the first time, calibrate the instrument (see 4.3 "Calibration")

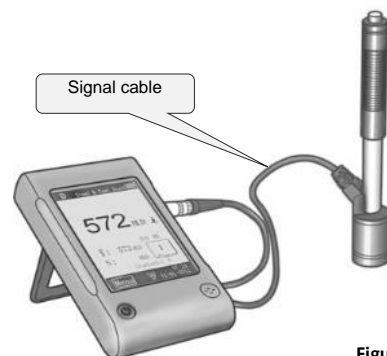
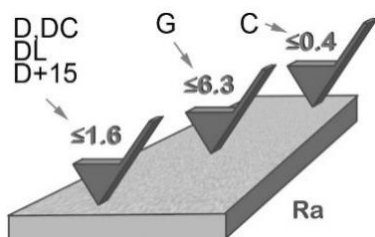

Figure 2-1

3.2 Preparation of the sample

Unsuitable material samples can cause measuring errors. Therefore, test preparation and execution should be carried out according to the sample properties. The preparation of the sample and its surface should meet these basic requirements:



During the surface preparation of the sample, its surface should not be exposed to thermal cooling or heating.

The test surface should be flat and have a metallic gloss. There must be no oxide layers or other contamination.

Roughness of the test surface

The sample should have sufficient mass and stiffness. If not, the impact may cause a displacement or movement, which may lead to a significant measurement error.

As a general rule, if the weight of the sample is 5 kg or more, testing can be performed directly.

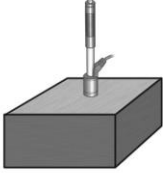
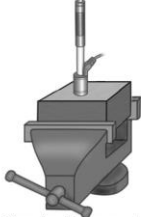
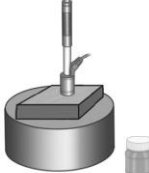
 <p>Direct Measurement</p>	 <p>Clamping Measurement</p>	 <p>Coupling Measurement</p>	English	German
			Direct measurement	Direct measurement
			Clamping measurement	Clamp measurement
<p>D/DC D+15,DL >5kg G >15kg C >1.5kg</p>	<p>2~5kg 5~15kg 0.5~1.5kg</p>	<p>0.05~2kg 0.5~5kg 0.02~0.5kg</p>	Coupling measurement	Coupling measurement

Sample thickness

The thickness of the sample as well as the thickness of the homogeneous layer (or the hardening layer of the surface) should have a sufficient material thickness.

If the sample surface is not flat, the radius of the test area should not be less than 30 mm (50 mm for type G). If it is not specified, an appropriate support ring should be used.

The sample should have no magnetic properties.

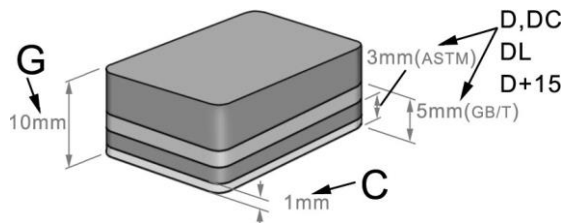

3.3 Test execution

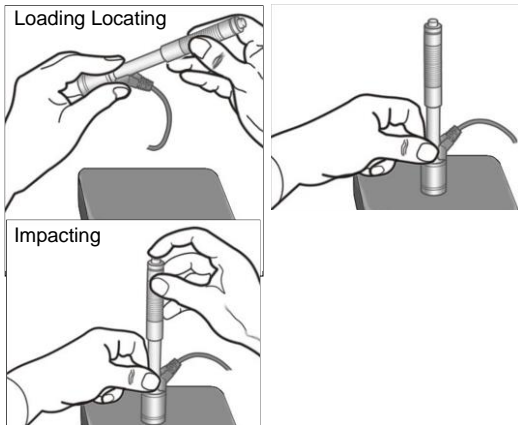

Shop

Load the impact device by pushing the loading tube forward.

Positioning

Then position the impact device and hold it on the surface of the sample at the desired measuring point. The direction of impact shall be perpendicular to the surface of the sample.

English	German
Loading	Shop
Locating	Positioning
Impacting	Impact

Impact (measurement)

Perform the measurement by pressing the release button. The measured hardness value is displayed immediately.

Reading test results

Read the measurement result of the test from the display.

Note:

Normally, 5 individual measurements are made at each measuring point of the sample. The value range (difference of the maximum and minimum value) should be less than 15 HL. The distance between any two measuring points should be $\geq 3\text{mm}$; the distance between the point of impact and the edge of the sample should be $\geq 3\text{mm}$.

3.4 Browse

The hardness tester enables hardness values to be stored, which can then be searched after the measurement has been completed. To do this, enter the menu to select the desired browse mode (see par. 3.2.3 for detailed information).



```

Test Report
-----
Impact Unit Type: D
Material : Steel&Caststeel
1  808 HLD  ▲  61.2 HRC
Date: 31-07-06 Time:18:21:27
2  808 HLD  ▲  61.2 HRC
Date: 31-07-06 Time:18:21:27
3  805 HLD  ▲  60.8 HRC
Date: 31-07-06 Time:18:21:27
4  808 HLD  ▲  61.2 HRC
Date: 31-07-06 Time:18:21:27
5  805 HLD  ▲  60.8 HRC
Date: 31-07-06 Time:18:21:27
-----
s = 3  HLD  00.4 HRC
x = 806 HLD  61.0 HRC
Printed: 31-07-06  18:21:27
    
```

Figure 2-7

3.5 Print

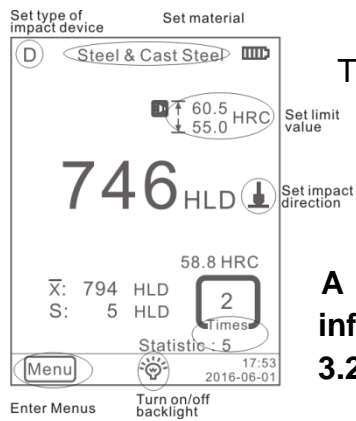

The hardness tester can be connected to a wireless printer to print a test report. Place the printer near the tester (at a distance of up to 2 m) and switch it on.

A test report is shown in Fig. 2-7. Detailed report information can be defined in the respective menu (see par. 3.2.2)

Fig. 2-6

English	German
Set type of impact device	Setting the type of impact device
Set material	Set material
Set limit value	Set limit value
Set impact direction	Setting the impact direction
Turn on/off backlight	Lighting ON / OFF
Enter menus	Call up the menu

4 Setup

The hardness tester is equipped with a touch display and most settings can be made directly from the main screen. Some functions require calling up the respective menu masks to make the desired settings or for operating purposes.

4.1 Settings in the main mask

The hardness tester is equipped with a touch display and the most common test parameters can be set directly in the main mask (Fig. 3-1).

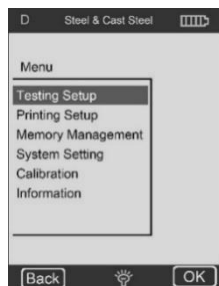

4.2 Menu settings

Test setting	Material group	System settings	Fabric Settings
	Impact direction		Automatic printing ON/OFF
	Scale		Gross error ON/OFF
	Limit values		Key tone ON/OFF
	Statistics		Alarm ON/OFF
	Workpiece		Language: EN
Pressure setting	Positions	Calibration	Date / Time
	Printing the memory contents		Lighting duration
	Print all		Test calibration
Memory	Search all	Information	Touch Calibration
	Browse Selected		
	upload data		
	Delete selected ones		
	Delete All		

To call up the desired menu masks, the menu in the main mask must be activated. In the respective menu:
 Press the "△" or "▽" button to scroll up or down the page
 press the **Back** key in the upper menu or return to the main screen.

4.2.1 Test settings

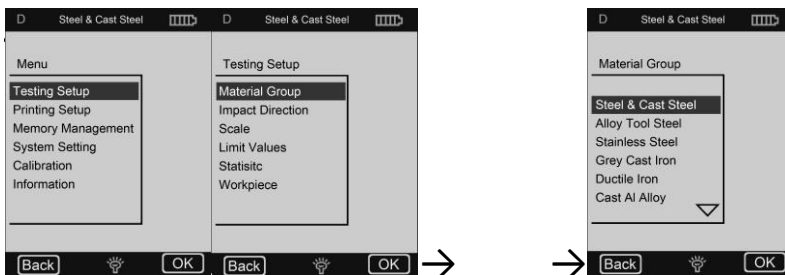

Fig. 3-2

Material group

The "Material group" function allows you to select materials to be tested. It only determines the conversion to other hardness scales. If only the Leeb hardness value is required, it can be disregarded.

If the material is not specified in the menu, the user must familiarise himself with the operating instructions in order to select a comparable type of material.

Impact direction

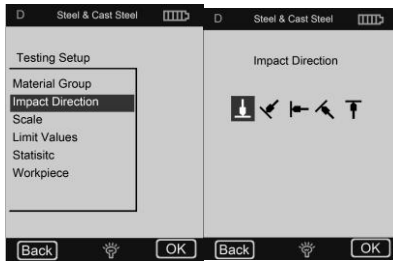

Fig. 3-4

- HB** - Brinell hardness
- HRB** - Scale B Rockwell
- HRC** - Scale C Rockwell
- HV** - Hardness according to Vickers
- MPa** - tensile strength
- ∅ no conversion

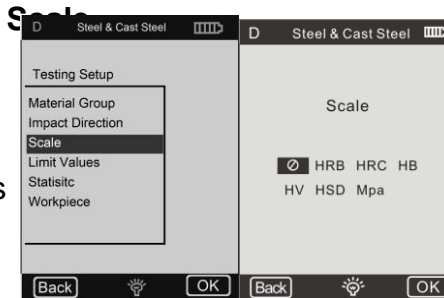

Fig. 3-5

Comments:

- ① Because different hardness scales can have different ranges, it is sometimes not possible to make a conversion. If this is the case, the symbol "---" is displayed.
- ② The set material group must be reset if the tensile strength (MPa) is selected.
- ③ As is generally known, the conversion is for reference purposes only. Comparative tests are required to ensure an accurate conversion.

Limit values

The max. limit value and the min. tolerance value are adjustable. If the measured hardness values are outside the range, the display immediately triggers a sound alarm.

The minimum and maximum limit values can be set using a digital keypad (Fig. 3-6).

To select a different position or digit, press \downarrow the or \uparrow key.

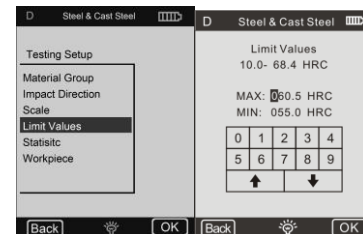

Fig. 3-6

Statistics

The device is equipped with an automatic statistics function. It allows you to set statistical parameters to determine the average (\bar{x}) and range value (S).

Important:

- ① The value range for statistical parameters is 1 ~ 99, whereby with the setting "1" no statistical processes are carried out by the system.
- ② If some items (material group etc.) are reset, the count starts from "0".

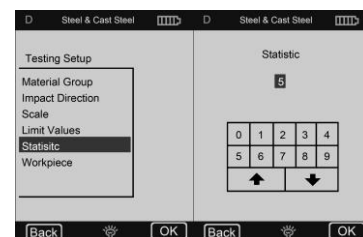

Figure 3-7

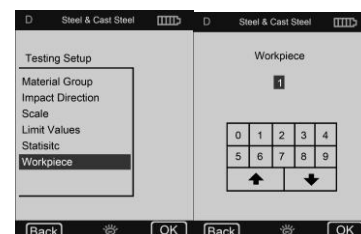

Fig. 3-8

6) Work piece

Grouping of test elements for the purpose of request, printing or data processing.

The range is 1-50 and can be saved.

4.2.3 Print settings

Position Select the position of the print report from the test.

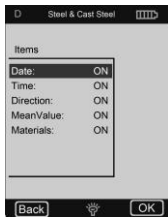

Figure 3-10

Print memory contents Here you can select the range of data to be printed.

Print all It is possible to print all measured values from the internal memory.

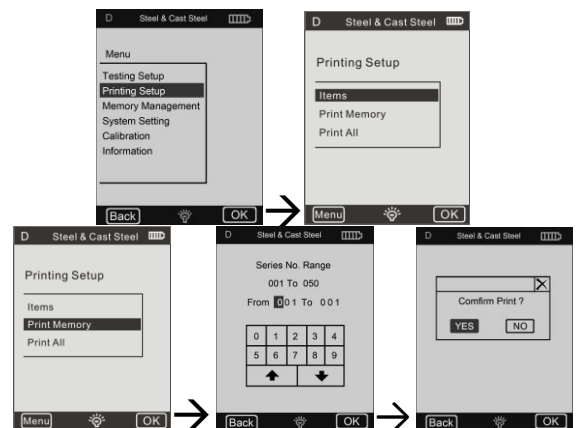

Fig. 3-11

4.2.4 Memory management

It is possible to browse data in the memory as well as delete data from the memory.

The stored test data includes all test information. Up to 500 data sets can be stored. If the memory is full, the oldest data is overwritten by the new data.

Therefore, it is recommended to save data in a different way (e.g. printing or uploading to PC) from time to time to prevent accidental data loss.

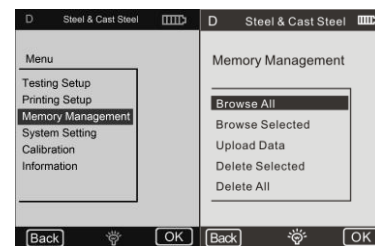

Fig. 3-12

Browse

The unit has three browse modes:

Search from A to Z, Search from Z to A and **browsing selected items**.

Press the or key to move the page up/down. to scroll down.

Press the key to delete a selected data group.

Press the key to print a selected data group.

Press the **OK** key to display - the test time of the selected data group.

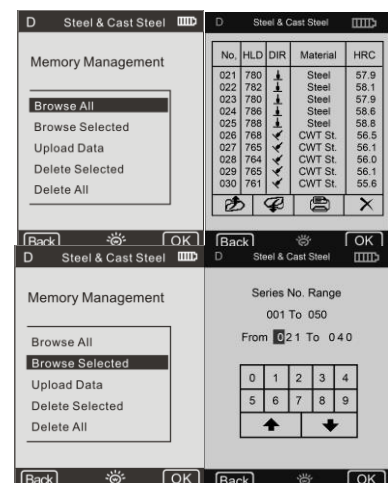

Fig. 3-14

Delete

It is possible to delete larger amounts of data or all data at once from the memory. It is recommended to delete the data individually.

IMPORTANT: Deleted data cannot be recovered. Therefore, it is recommended to use the delete function with care.

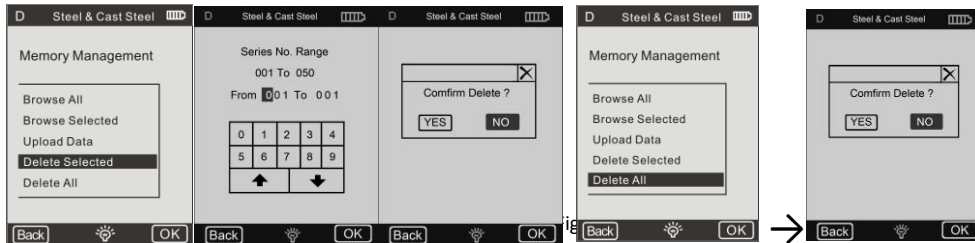

Fig. 3-15

Fig. 3-16

3) Upload data

The data from the memory can be transferred to the PC can be uploaded.

To do this, connect the PC and start the upload software call (Ehard).

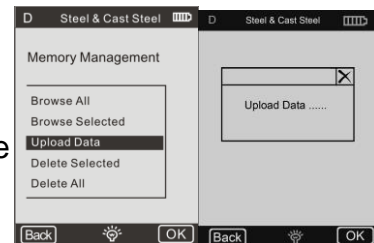

Fig. 3-17

Select the **Upload Data** function, then the data can be received or processed in the software by PC.

Detailed information can be found in the operating instructions for the software.

4.2.5 System settings

Material settings

It is possible to adapt conversion tables as required and to select them for material "A", "B" and "C".

It is possible to select a scale as required and enter data in the conversion table (Fig. 3-19)

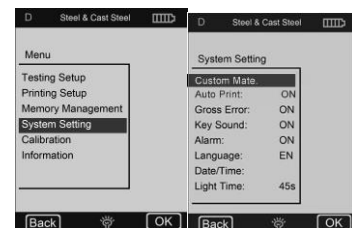

Fig. 3-18

Automatic printing

If the "Automatic printing" function is active (ON), a test report is printed automatically after the test of the respective statistics group is completed (the printer must be switched on).



Fig. 3-19

Coarse error

If the function "**Gross error**" is active (ON), gross errors are displayed according to the settings for Grubbs after the determination of "**Statistical parameters**".

5 Care and maintenance

5.1 Periodic maintenance

General information

Avoid shocks. After use, place the device back into the transport case.

The rebound sensor must be stored in a triggered state.

Avoid use in a strong magnetic field. Protect all components from any contact with grease or oil.

Clean impact device

In principle, the tube and the housing of the impact device must be cleaned every 1 to 2 thousand measurements.

Replacement of the impact ball

Continuous use may damage the impact ball. It shall be replaced as soon as its condition appears to affect the accuracy of the measurement.

5.2 Shop

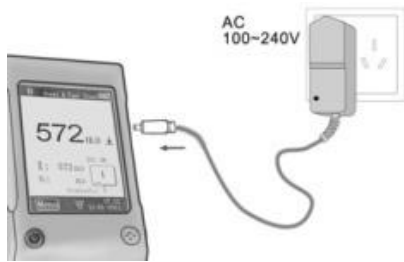

Fig. 4-2

5.3 Calibration

Test Calibration

The method is used to calibrate the instrument to reduce the extent of the error in the future.

To do this, select the "Test calibration" function. Select the type of impact device. Then select the scale on which the calibration is to be carried out.

If HL is selected, the calibration mask can be selected directly.

If a different scale is selected, select the fabric type for the test piece that is used by default.

Perform 5 effective measurements on the test block (if the alarm function is active (ON) and the number of strokes is less than 5, press the OK key; a query is made as to whether operating errors should be displayed), measured values are displayed (it is possible to delete incorrect values and return).

Touch calibration

This procedure is used to calibrate the correspondence between the sensor of the touch display and the display parameters.

If there are deviations between the actual position of press contacts of the touch display and the actuating position of displayed values, a touch calibration must be carried out.

To do this, simply press the centre of the crossing line or the square frame according to the displayed note.

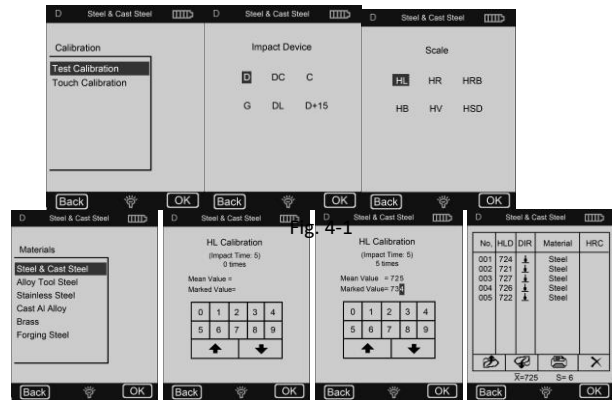

Fig. 4-3

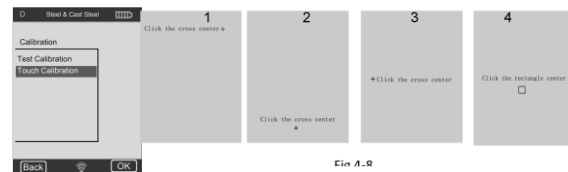
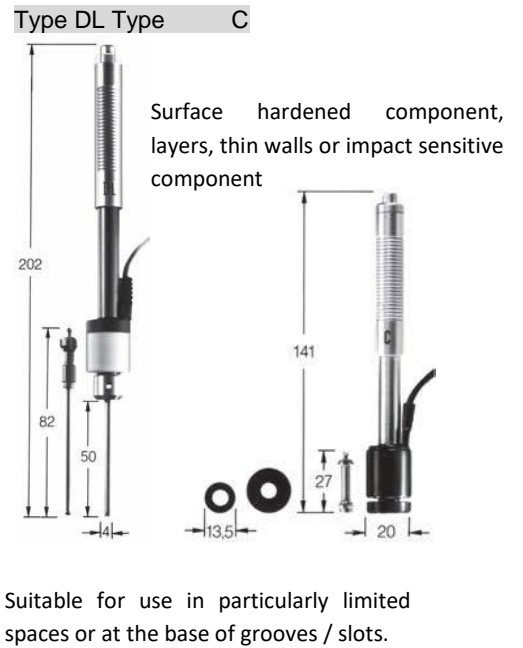
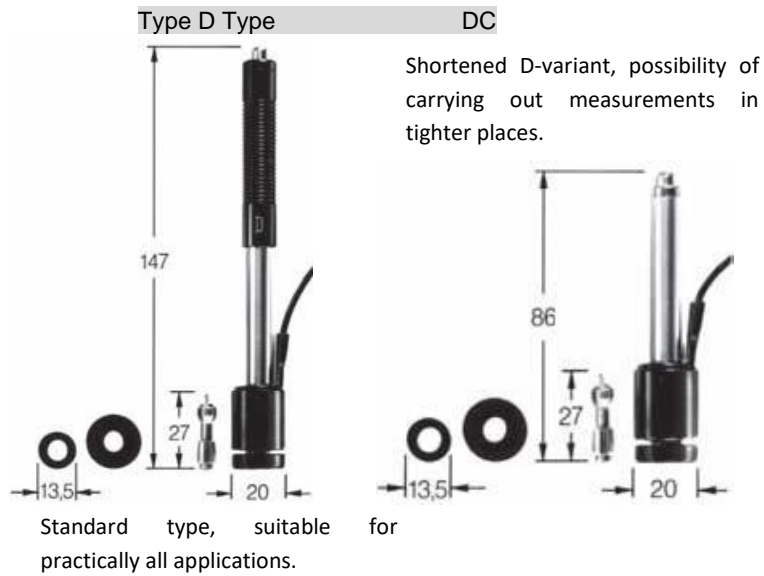

Fig. 4-4

6 Annex

Impact device type A-1



Type D+15 Type G

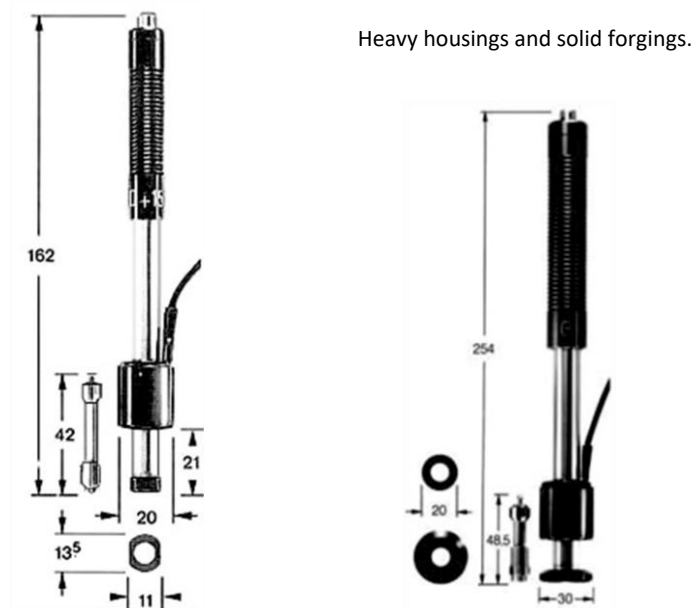

Especially thin front part, measuring coil with feedback. Suitable for hardness testing on grooves/grooves and on surfaces with indentations.

6.1 Conversion area

Type	Materials	HV	HB	HRC	HRB	HSD	Mpa	Steel	DL 560-950	C 350-960	D+15 481-850
D,DC	Steel & Cast steel	81~955	81~654	20~68.4	38.4~99.5	32.5~99.5	375~639	HV	81~955	80~996	192~825
	Alloy Tool Steel	80~898		20.4~67.1			375~2639	HB	81~654	80~683	188~654
	Stainless Steel	85~802	85~655	19.6~62.4	46.5~101.7		740~1725	HRC	20~68.4	20~69.5	20~64
	Grey Cast Iron		63~336					HRB	38.4~99.5		
	Ductile Iron		140~387					HSD	32.5~97.9	31.9~102	32.5~88.4
	Cast Al Alloy		19~164					G	Steel	Grey Cast Iron	Ductile Iron
	Brass		40~173		23.8~84.6						
	Bronze		60~290		13.5~95.3			HLG	300~750	340~600	340~600
	Copper		45~315					HB	90~646	92~326	127~364
	Forging Steel	83~976	142~651	19.8~68.5	59.6~99.6	26.4~99.5		HRB	47.7~99.9		

English	German
Type	Type
Material	Material
Steel	Steel
Cast steel	Cast steel
Alloy tool steel	Tool Steel Alloy
Grey cast iron	Grey cast iron
Ductile iron	Ductile cast iron
cast al alloy	Aluminium casting alloy
Brass	Brass
Bronze	Bronze
Copper	Copper
Forging steel	Forged steel

6.2 Scope of delivery

1. Display
2. Impact device
3. Test block
4. Mini Printer
5. Battery charger
6. Small support ring,
Cleaning brush
7. Operating instructions
8. Transport case

Note:

To view the CE declaration, please click on the following link:

<https://www.kern-sohn.com/shop/de/DOWNLOADS/>